

Genesis Arts™

Your Imagination Our Creation

+91 98276 30052 | +91 88716 53852

MOULDING PROFILE DESIGNS

1022-A
3/4 x HEIGHT AS REQUIRED

2006
3/4 x HEIGHT AS REQUIRED

2007
7/8 x HEIGHT AS REQUIRED

2009
15/16 x HEIGHT AS REQUIRED

2017
3/4 x HEIGHT AS REQUIRED

2018
7/8 x HEIGHT AS REQUIRED

3027-B
3/4 x HEIGHT AS REQUIRED

3043
1 1/4 x HEIGHT AS REQUIRED

3067-AB
1 5/8 PROJECTION x HEIGHT AS REQUIRED
BASE SHOE 4039

3083-A
1 1/4 x HEIGHT AS REQUIRED

3106-AB
1 15/16 PROJECTION x HEIGHT AS REQUIRED

3131-A
1 11/16 PROJECTION x HEIGHT AS REQUIRED
BASE SHOE 7148

4005
5/8 x HEIGHT AS REQUIRED

4006
3/4 x HEIGHT AS REQUIRED AS REQUIRED

4019
3/4 x HEIGHT AS REQUIRED AS REQUIRED

4035
7/8 x HEIGHT AS REQUIRED

6033
3/4 x HEIGHT AS REQUIRED

6040-A
3/4 x HEIGHT AS REQUIRED

7003
3/4 x HEIGHT AS REQUIRED

7004
11/16 x HEIGHT AS REQUIRED

7006
3/4 x HEIGHT AS REQUIRED

7011
13/16 x HEIGHT AS REQUIRED

7012
3/4 x HEIGHT AS REQUIRED

7013
1 3/8 x HEIGHT AS REQUIRED

7014
15/16 x HEIGHT AS REQUIRED

7017
13/16 x 5 1/2 MAXIMUM HEIGHT

7018
HEIGHT AS REQUIRED

7019
1" x HEIGHT AS REQUIRED

7020
3/4 x HEIGHT AS REQUIRED

7021
3/4 x HEIGHT AS REQUIRED

7022
3/4 x HEIGHT AS REQUIRED

7026
3/4 x HEIGHT AS REQUIRED

7029
3/4 x HEIGHT AS REQUIRED

7033
15/16 x HEIGHT AS REQUIRED

7035
7/8 x HEIGHT AS REQUIRED

7038
3/4 x HEIGHT AS REQUIRED

7039
7/8 x 6 1/2 MAXIMUM HEIGHT

7042
7/8 x HEIGHT AS REQUIRED

7043
13/16 x 7 1/2 MAXIMUM HEIGHT

7046
3/4 x HEIGHT AS REQUIRED

7048
7/8 x HEIGHT AS REQUIRED

7049
1 1/4 x HEIGHT AS REQUIRED
BASE SHOE 7048

7051
3/4 x HEIGHT AS REQUIRED

7052
3/4 x HEIGHT AS REQUIRED

7063
1 1/16 x HEIGHT AS REQUIRED

7064
1 1/16 x HEIGHT AS REQUIRED
BASE CAP 6001
BASE SHOE 4039

7071
3/4 x HEIGHT AS REQUIRED

7072
3/4 x 6 1/2 MAXIMUM HEIGHT

7075
5/8 x HEIGHT AS REQUIRED

7076
3/4 x HEIGHT AS REQUIRED

7085
7/8 x HEIGHT AS REQUIRED

7086
7/8 x HEIGHT AS REQUIRED

7087
1 1/16 x HEIGHT AS REQUIRED
BASE SHOE 7088

7090
3/4 x HEIGHT AS REQUIRED

7092
5/8 x HEIGHT AS REQUIRED

7101
3/4 x HEIGHT AS REQUIRED
BASE SHOE 7102

7107
15/16 x HEIGHT AS REQUIRED
BASE SHOE 7015

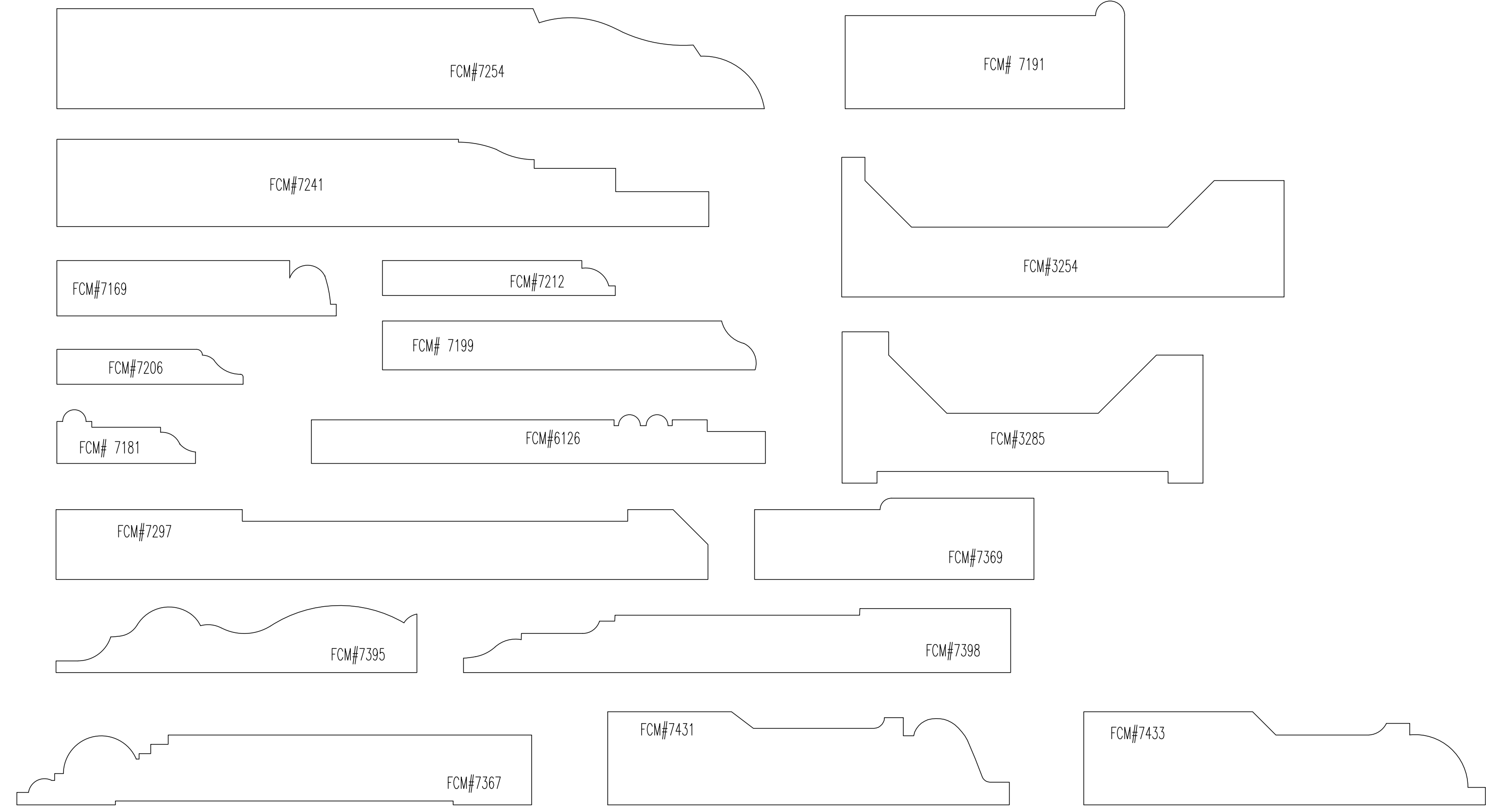
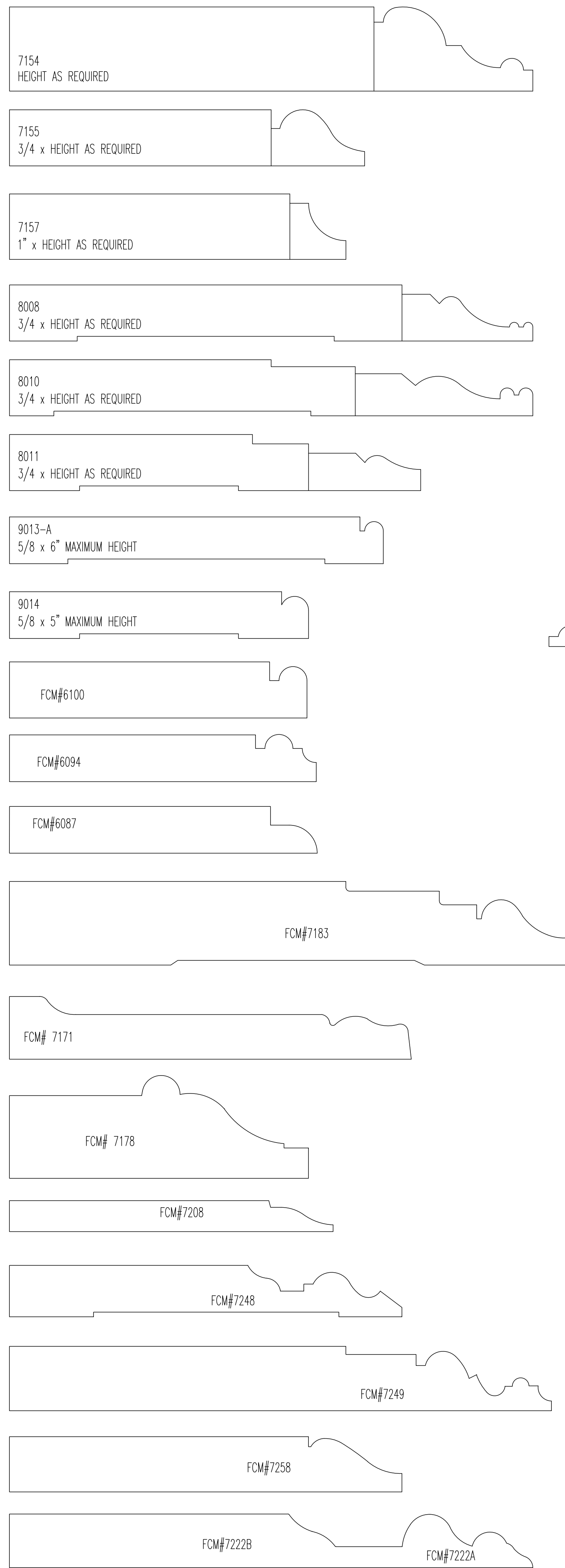
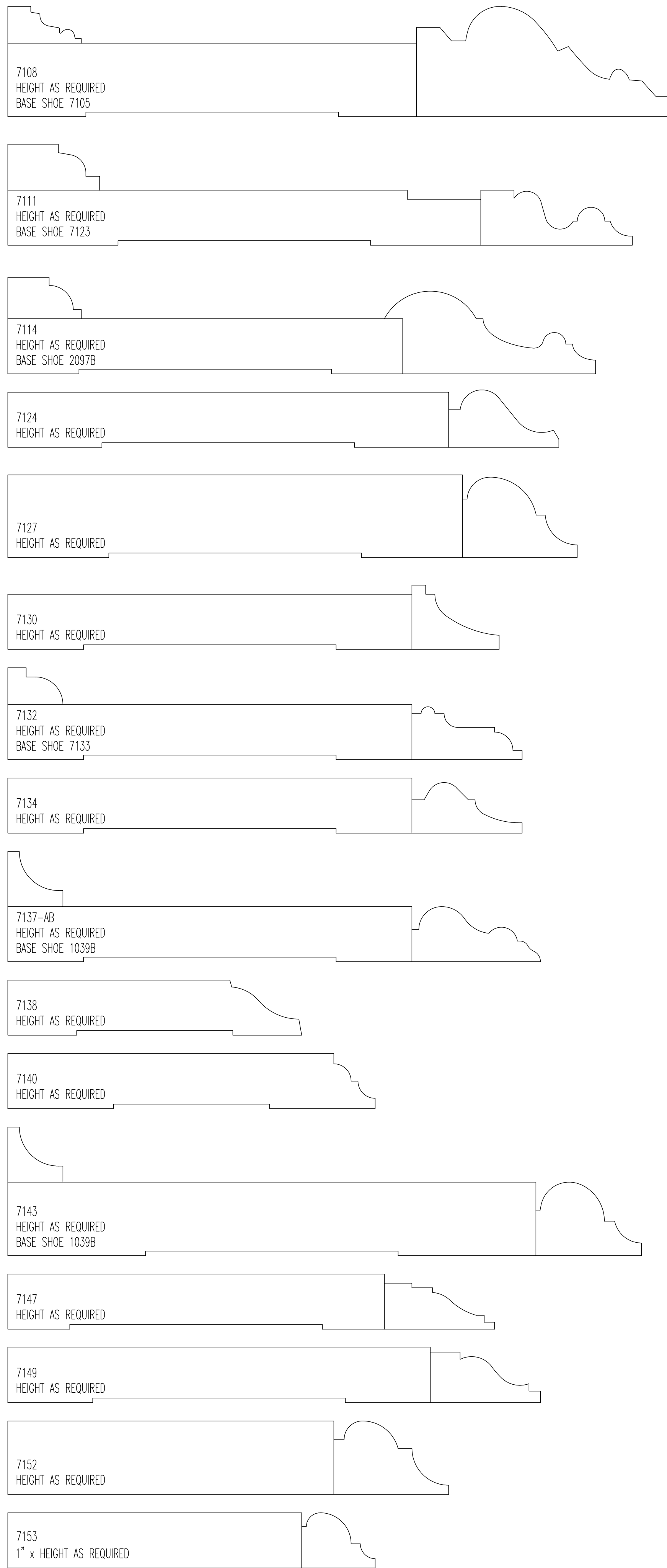

BASE CAP

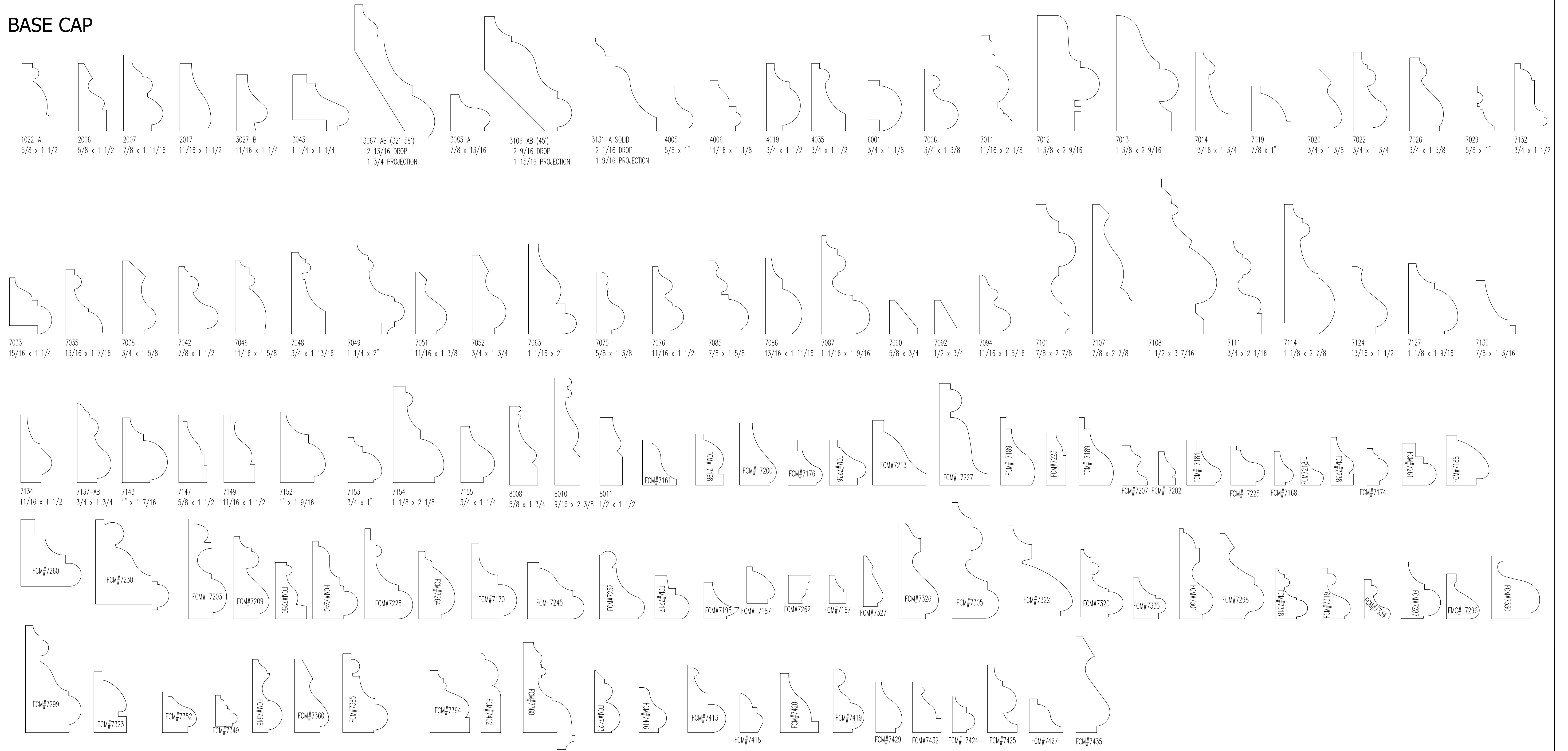

BASE SHOE

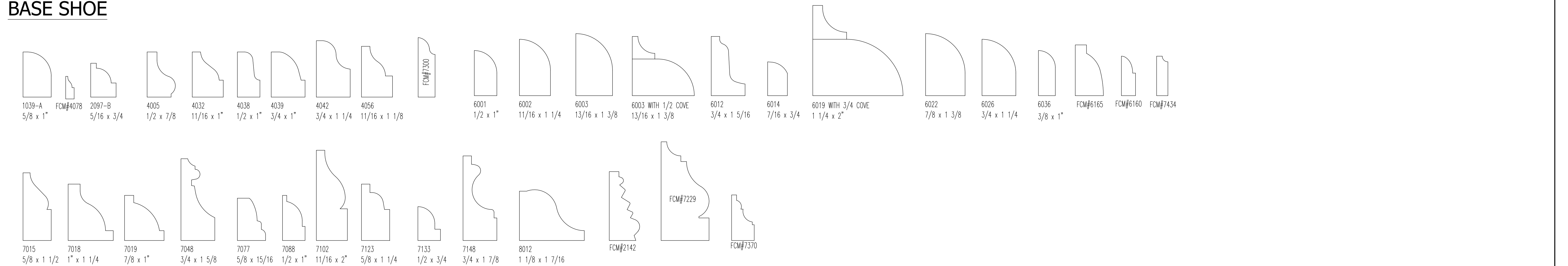

2" CASING

2002
3/4 x 2 1/2

2004
1 1/16 x 2 5/16

2011
3/4 x 2 7/16

2013
3/4 x 2 5/16

2014
1 1/8 x 2 3/4

2019
3/4 x 2 3/16

2029
1 1/16 x 2 3/8

2031
13/16 x 2 7/8

2049
1 3/16 x 2 9/16

2050
1" x 2 1/2

2053
1" x 2 1/4

2067
3/4 x 2 3/4

2085
13/16 x 2 9/16

2094
7/8 x 2"

2095
7/8 x 2 1/4

2125-AB
1 3/8 x 2 3/8

6004
3/4 x 2 15/16

FCM#2253

7021
3/4 x 2 1/2

7071
3/4 x 2 3/4

7109-AB
1 5/16 x 2 13/16

FCM# 2161

FCM#2140

FCM#2144

FCM# 2141B
FCM# 2141A

FCM#2199

FCM#2173

FCM#2146

FCM#2135

FCM#2177

FCM# 2153

FCM#2165

FCM#2197

FCM#6089

FCM#2241

FCM#6090

FCM# 7180

FCM# 7186

FCM# 7214

FCM#7244

FCM#2209

FCM#2210

FCM#2211

FCM# 2249

FCM#2227

FCM#2229

FCM#2247

FCM#2222

FCM#2236

FCM#2231B

FCM#2226

FCM# 2230

FCM#7309

FCM#7315

FCM# 7293

FCM# 7294

FCM#7346

FCM#2255 A&B

FCM#3342

FCM#2278

FCM#2263

FCM#2277

FCM#2280

FCM#2300

FCM#2279

FCM#2265

FCM#2302

FCM#2297

3" CASING

2001
7/8 x 3 1/2

2008-B
3/4 x 3"

2012
1" x 3 1/2

2024
1 1/8 x 3

2025
1 3/16 x 3 5/16

2026
1" x 3 1/2

2028
1 5/16 x 3 11/16

2033
1" x 3 1/2

2035
1 1/16 x 3 1/2

2039
1 1/4 x 3"

2042
1 1/4 x 3 1/2

2046-B
1/2 x 3 1/4

2047
1 1/16 x 3 5/16

2062
1 5/16 x 3 3/4

2077
1 3/4 x 3 1/2

FCM#6127

2078
1 3/4 x 3 1/8

2082
3/4 x 3 1/2

2090-A
13/16 x 3 7/8

2091-A
11/16 x 3 5/8

2092
1 1/4 x 3"

2093
1 1/16 x 3 7/8

2096-A
3/4 x 3 7/8

2099
1/2 x 3 1/4

2105
1" x 3 1/2
FOR CURVED MILLWORK USE 2105-A

2121
1 1/4 x 3"

2128
3/4 x 3 1/16

2130
1" x 3 3/4

6020
3/4 x 3"

FCM#2138

FCM#2186

FCM#2200

FCM# 7173

FCM#2198

FCM#2133

FCM#2194

FCM#2190

FCM 2188

FCM# 2179 A FCM# 2179 B

FCM# 2148 FCM# 2149

FCM# 2150 FCM# 2151

FCM# 2159

FCM# 2157

FCM#2184

FCM#2196

FCM#2143

FCM#2298

FCM#2206

FCM 2203

FCM# 2204

FCM# 2205

FCM#2219

FCM#2220

FCM#2252

FCM#2246

FCM#2225

FCM#2243

FCM#2237

FCM#2232

FCM#2282

FCM#2261

FCM#2292

FCM#2284

FCM#2285

FCM#2286

FCM#2287

FCM # 2288

FCM#2290

FCM#2299

FCM# 2289

FCM#2295

FCM#2281

FCM#2291

PLINTH

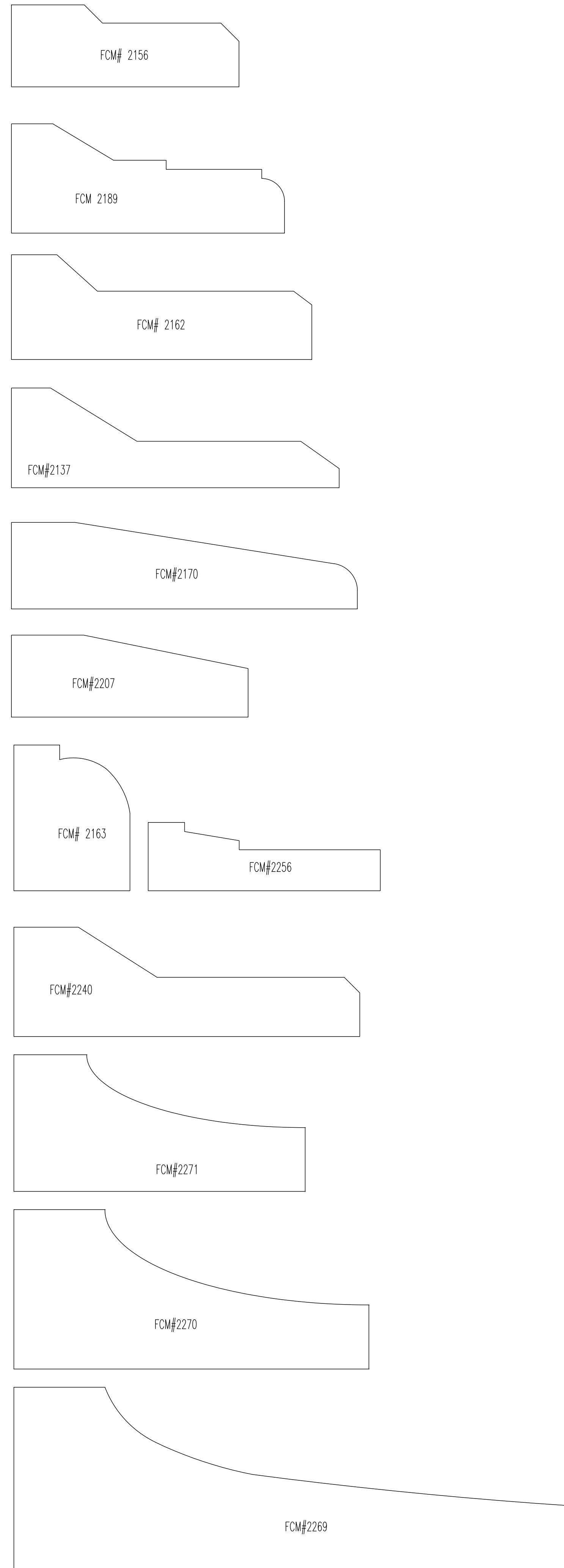

4" CASING

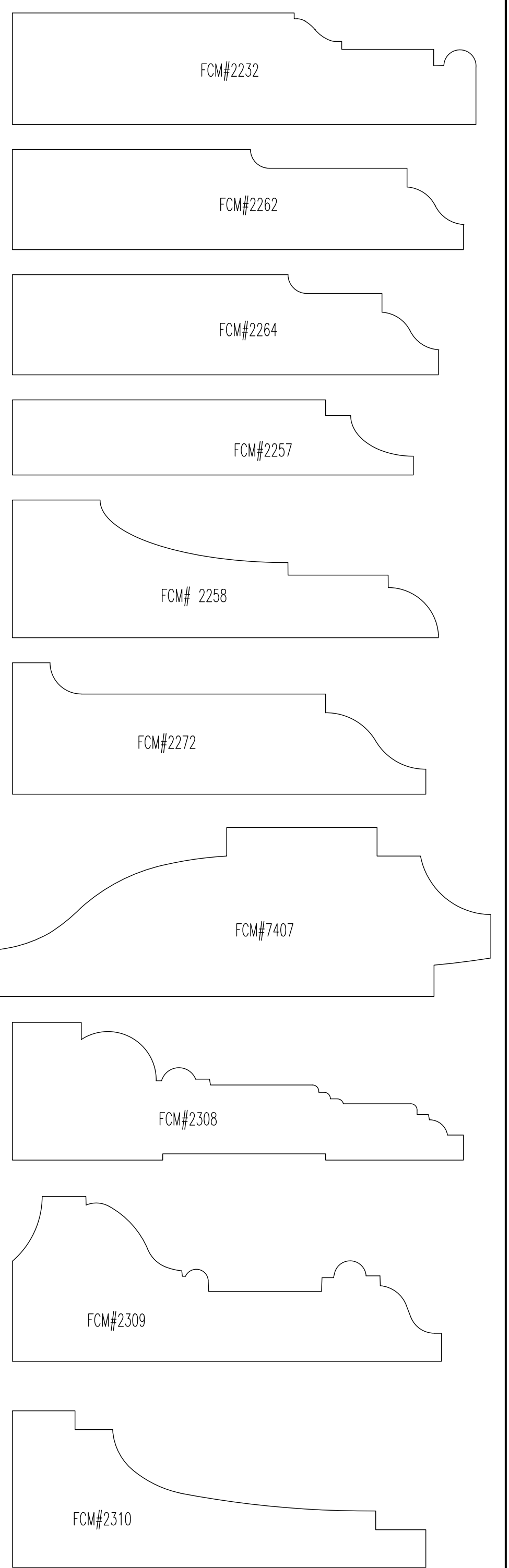
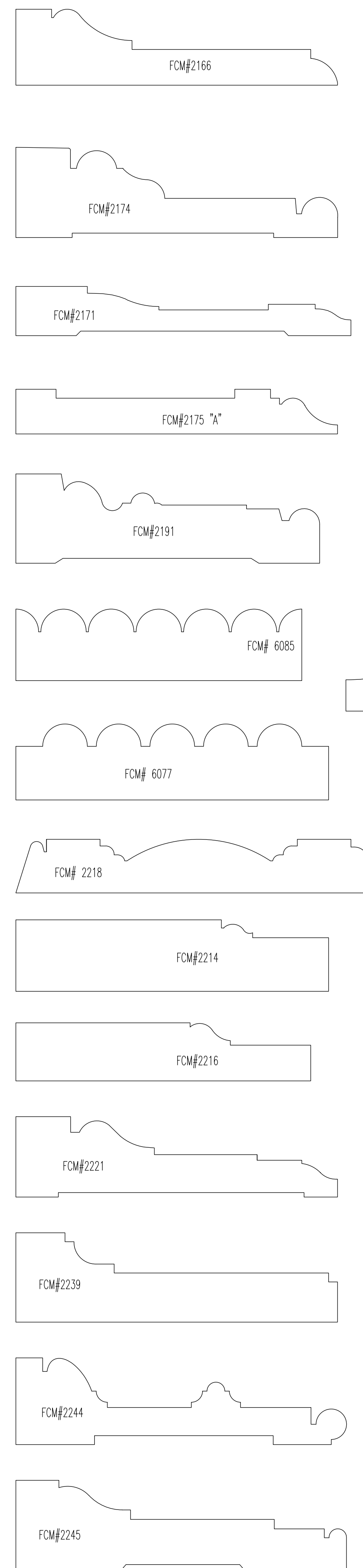
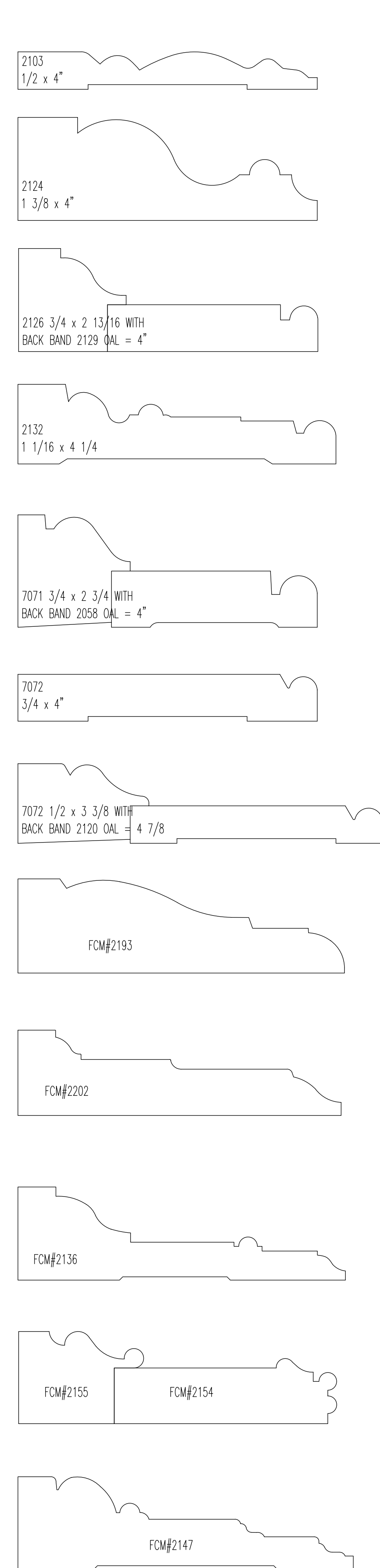
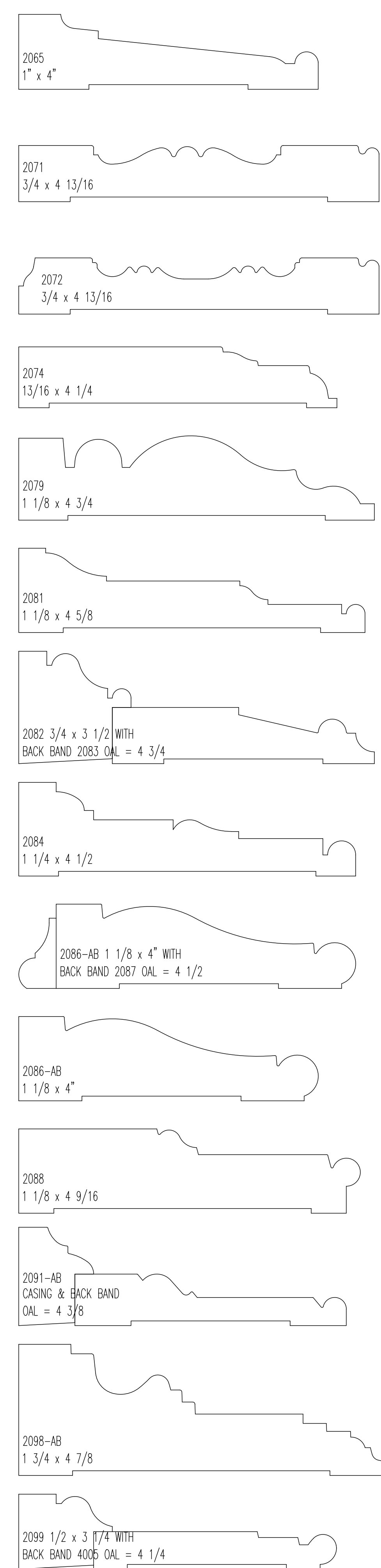
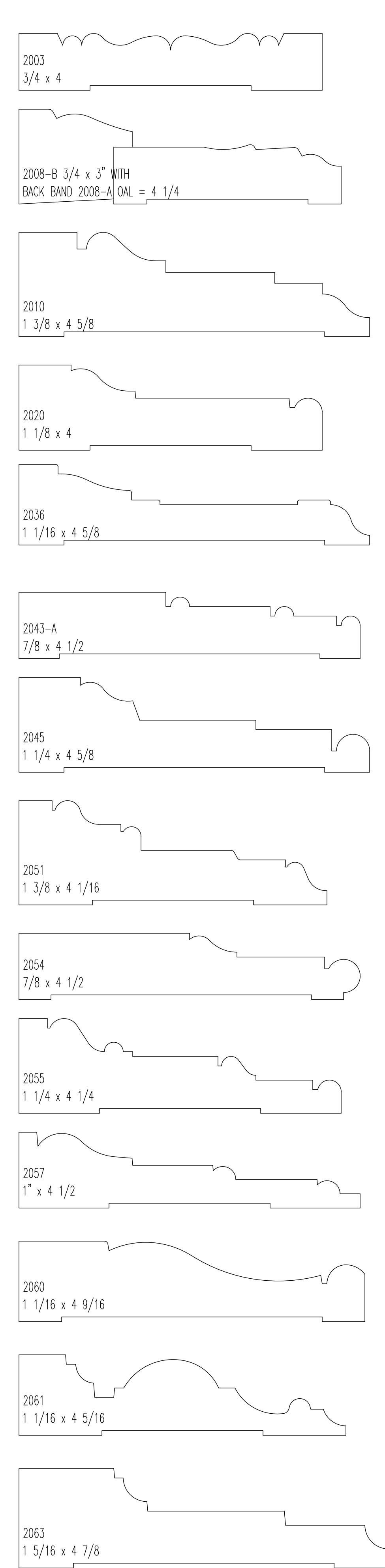

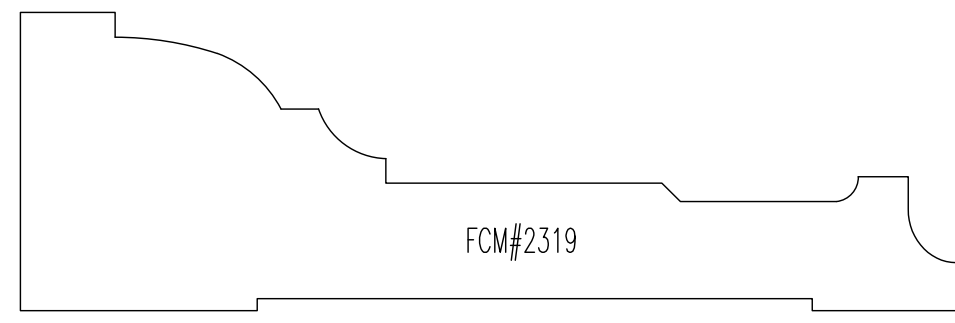
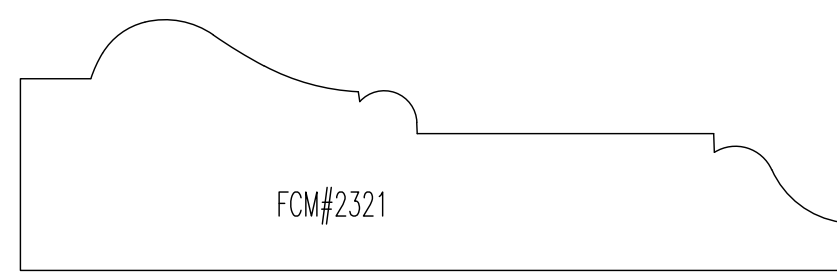
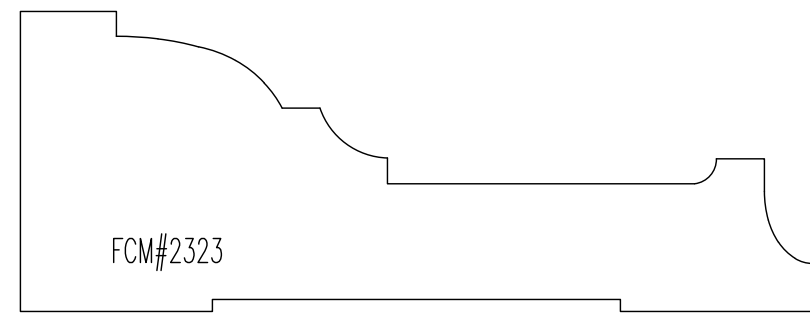
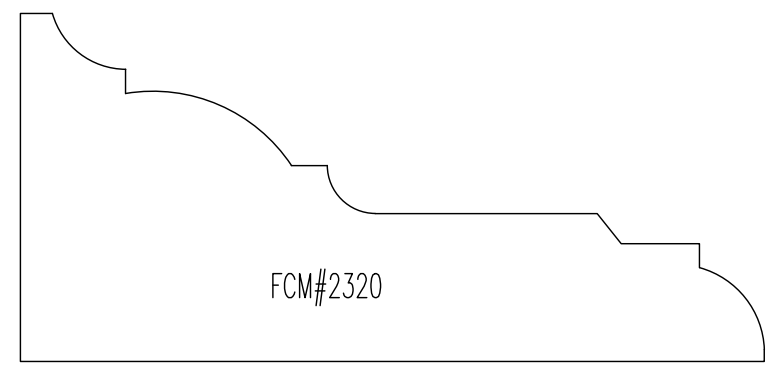
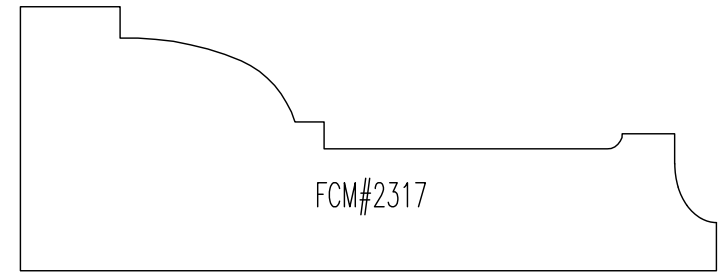
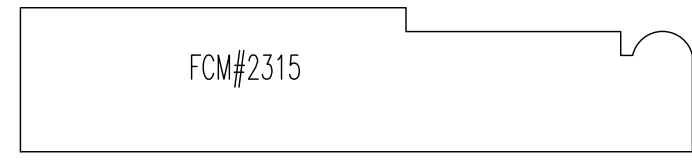
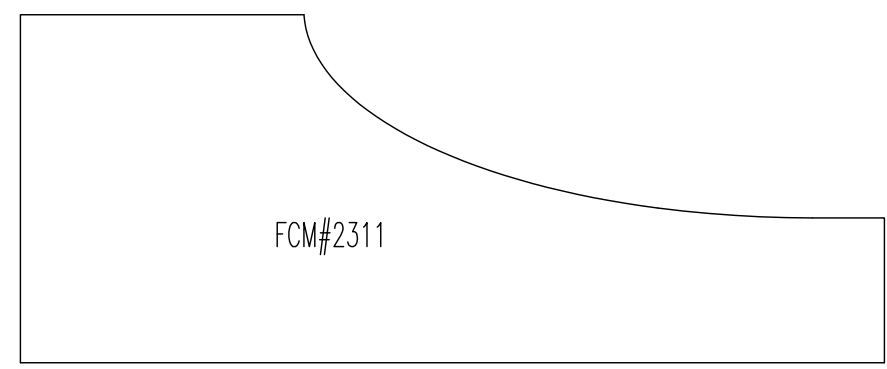

5" CASING

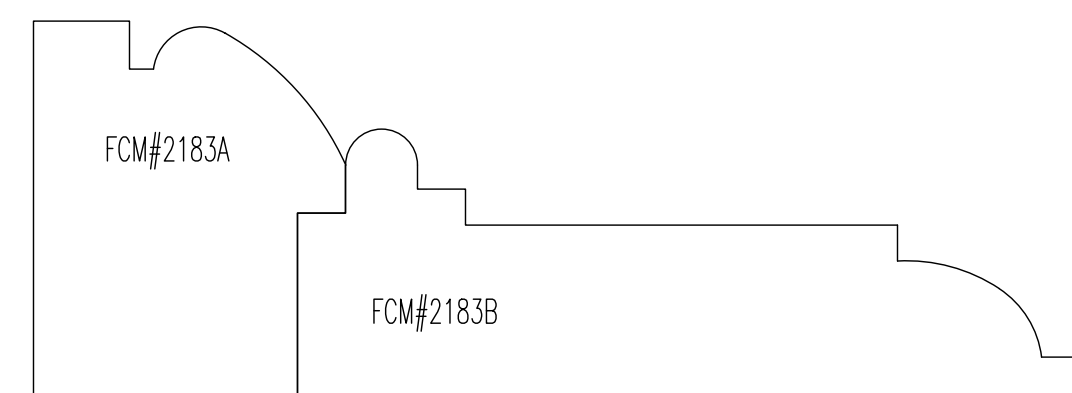
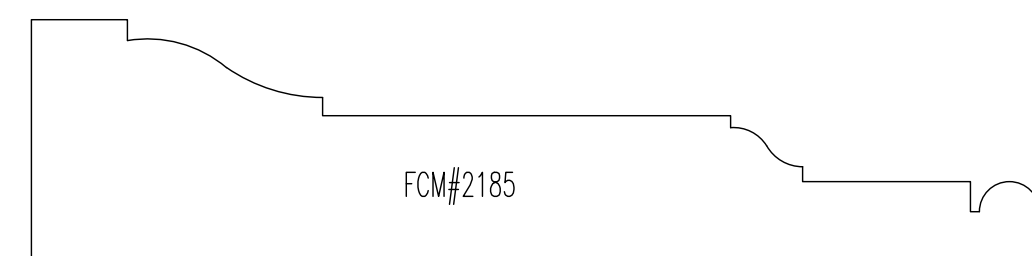
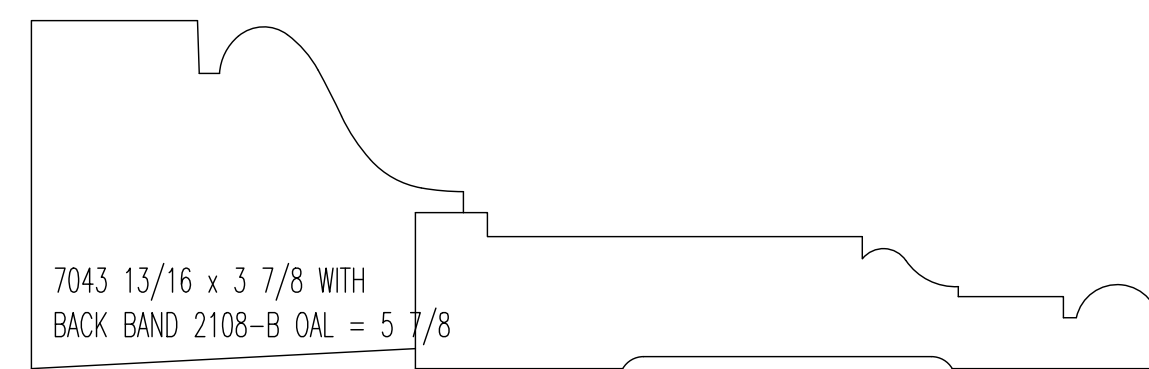
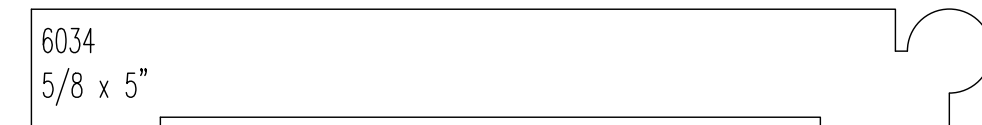
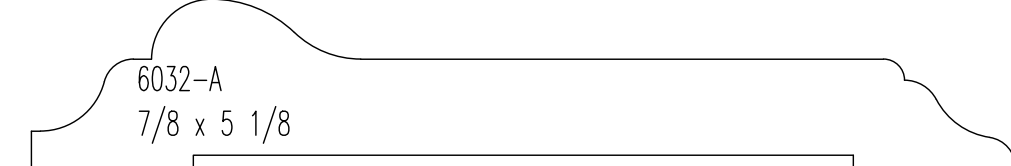
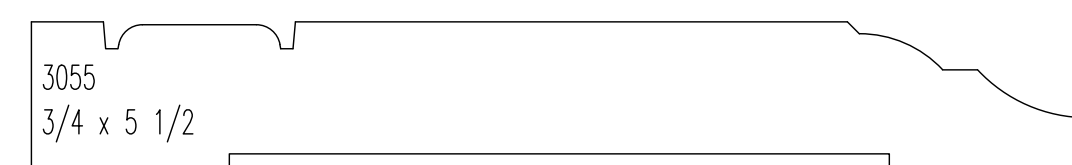
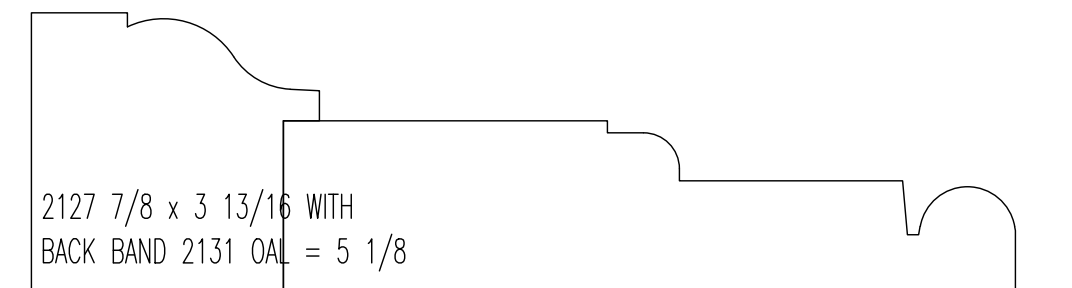
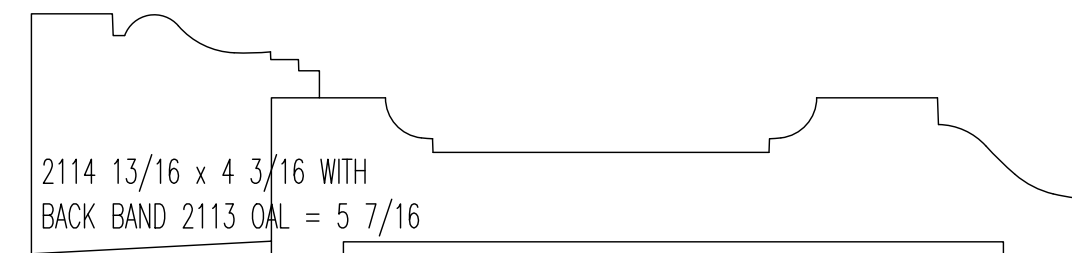
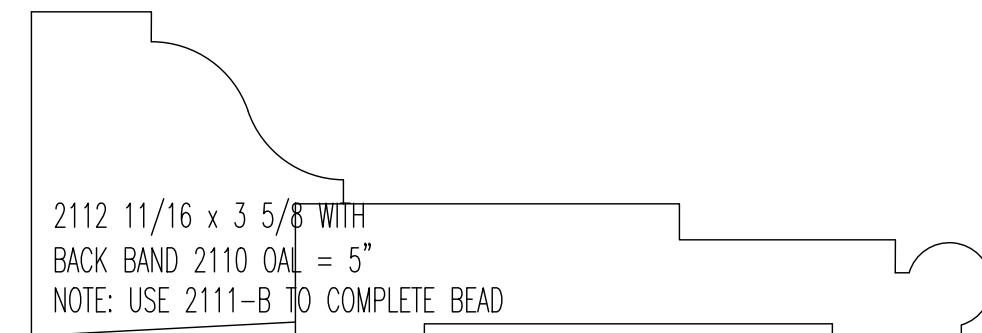
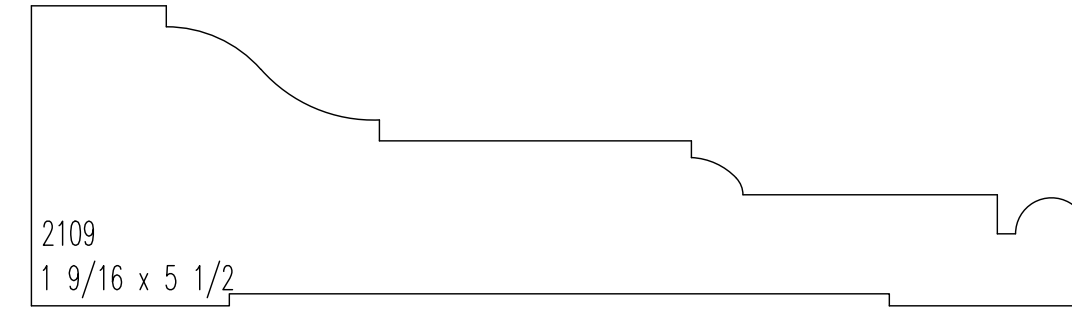
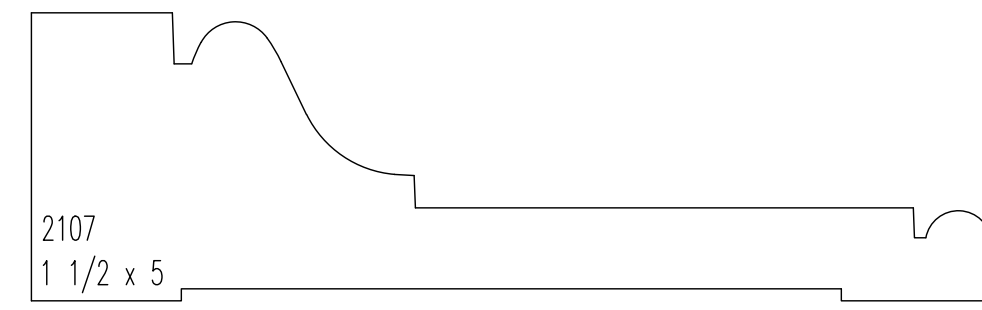
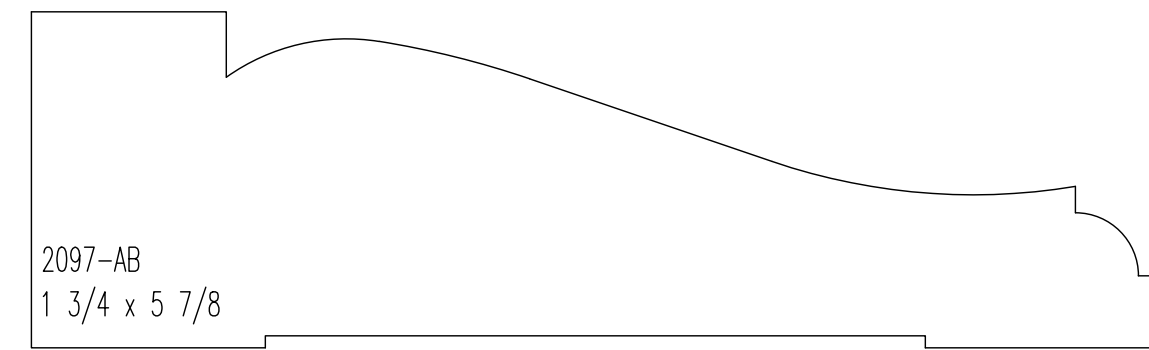
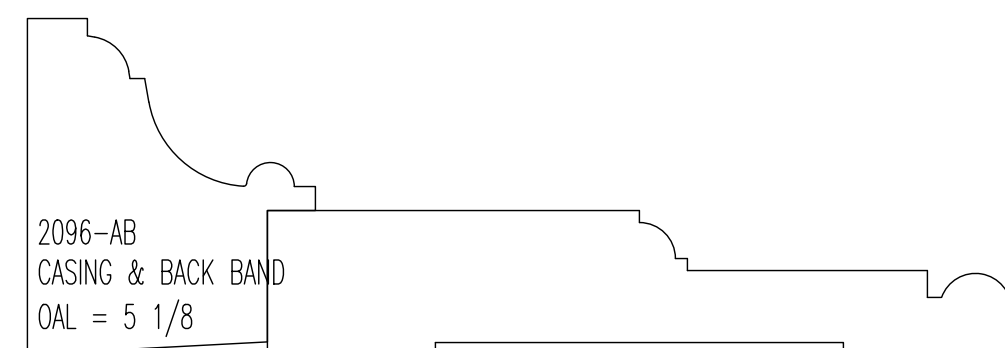
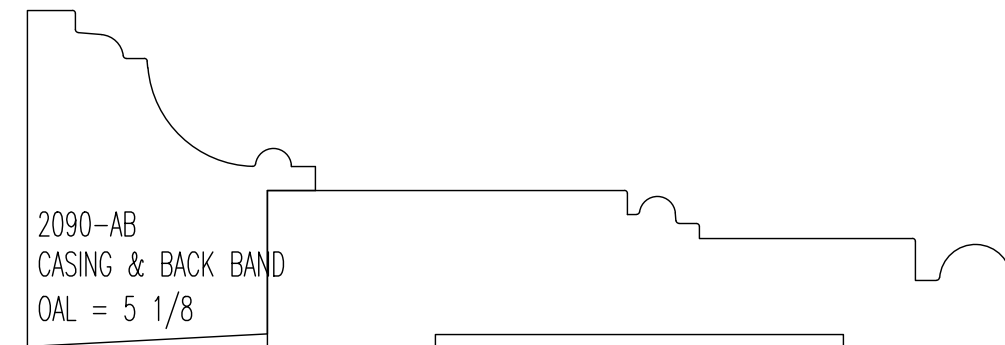
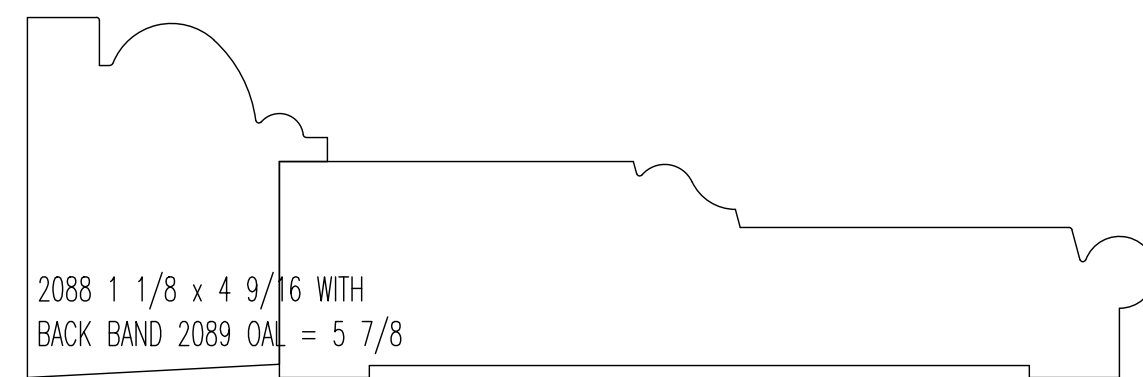
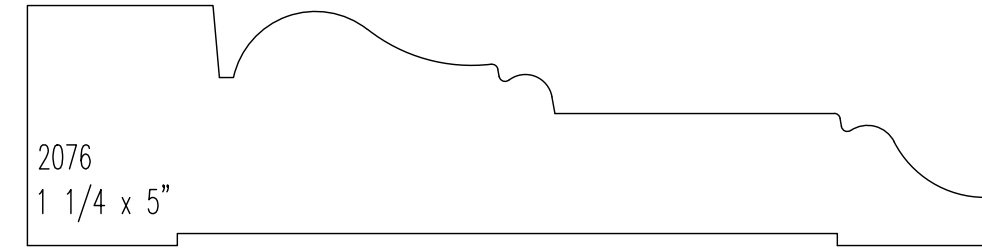
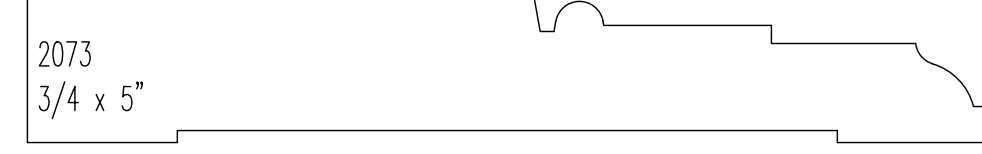
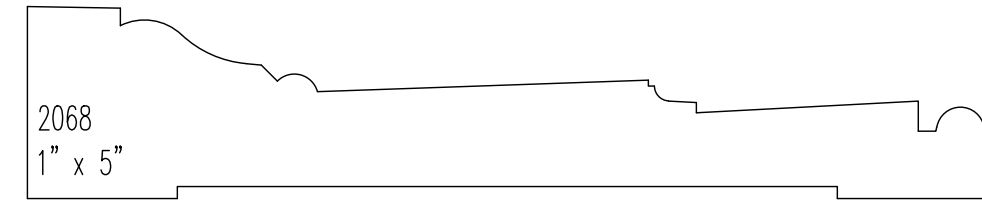
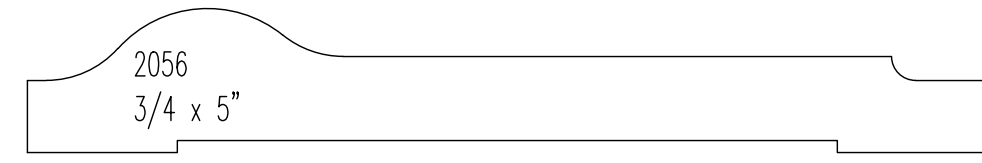
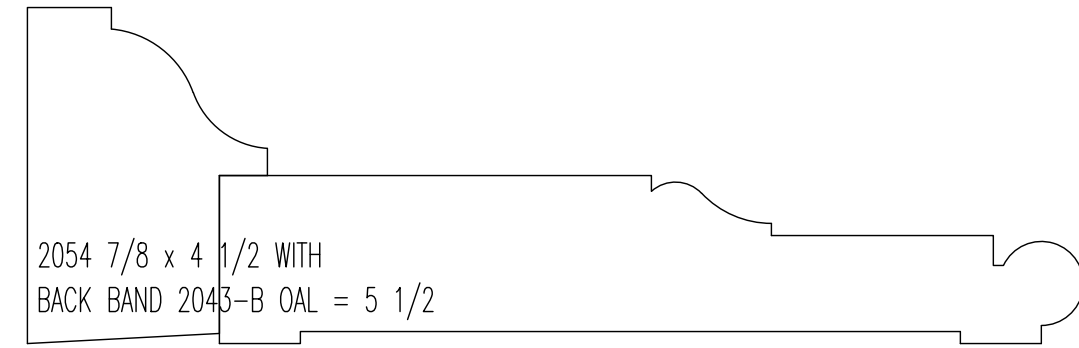
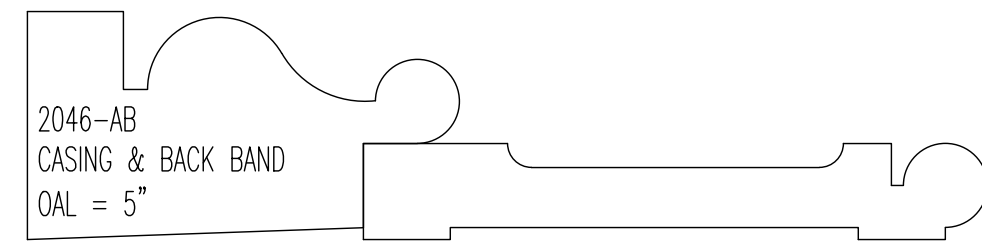
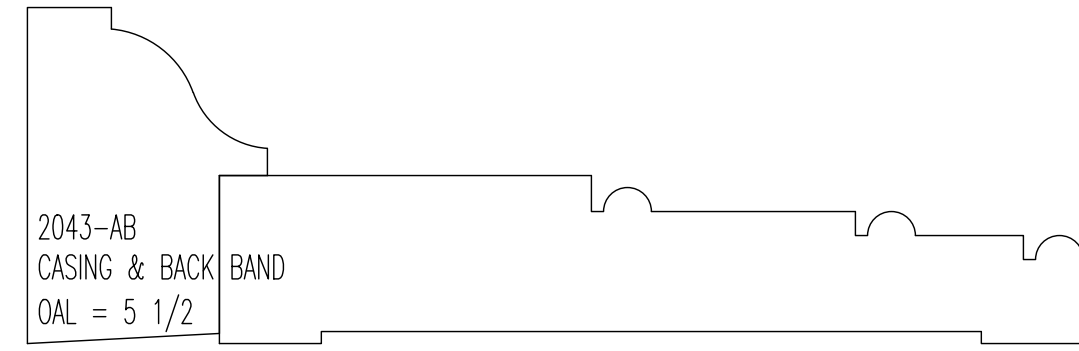
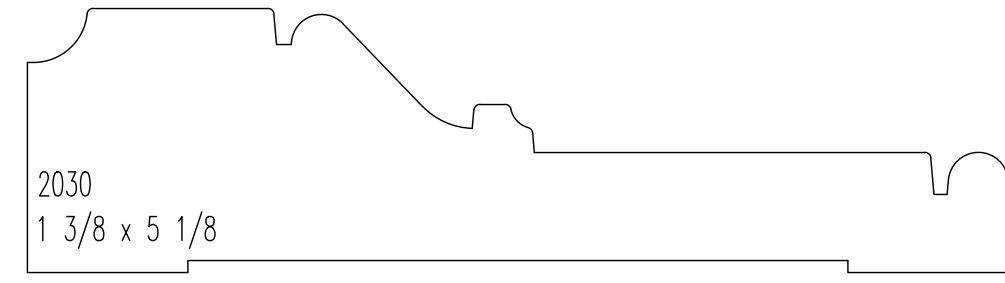
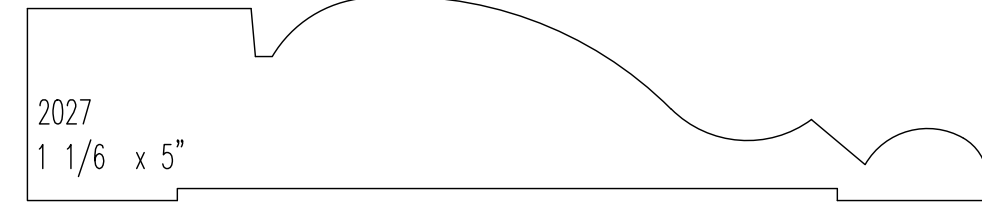
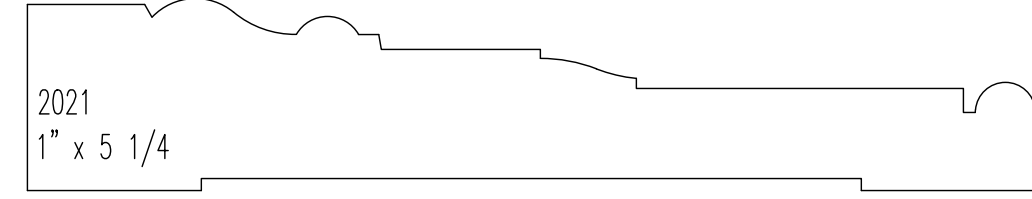

6" CASING

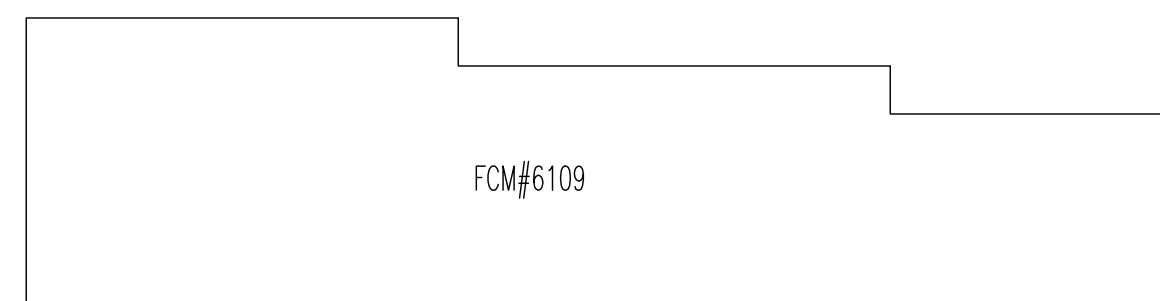
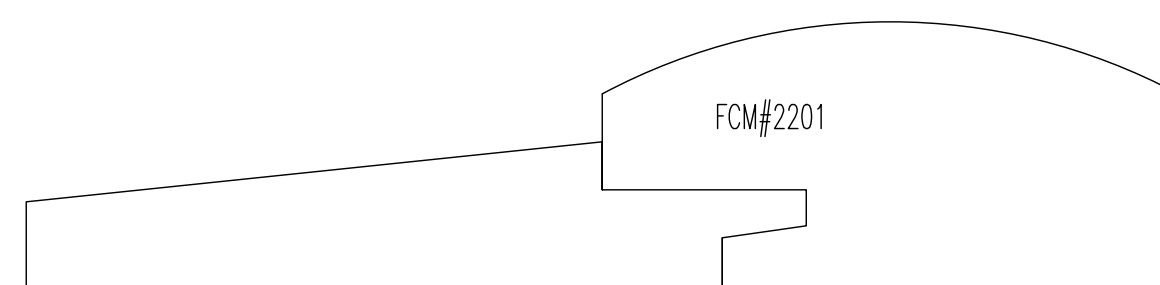
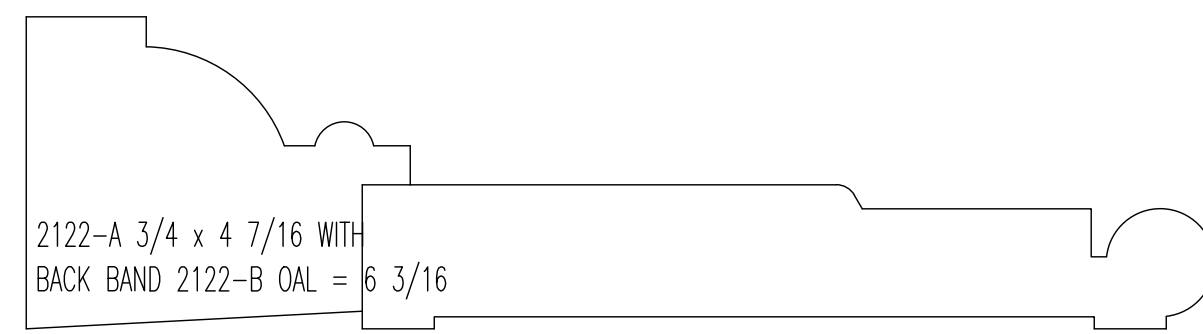
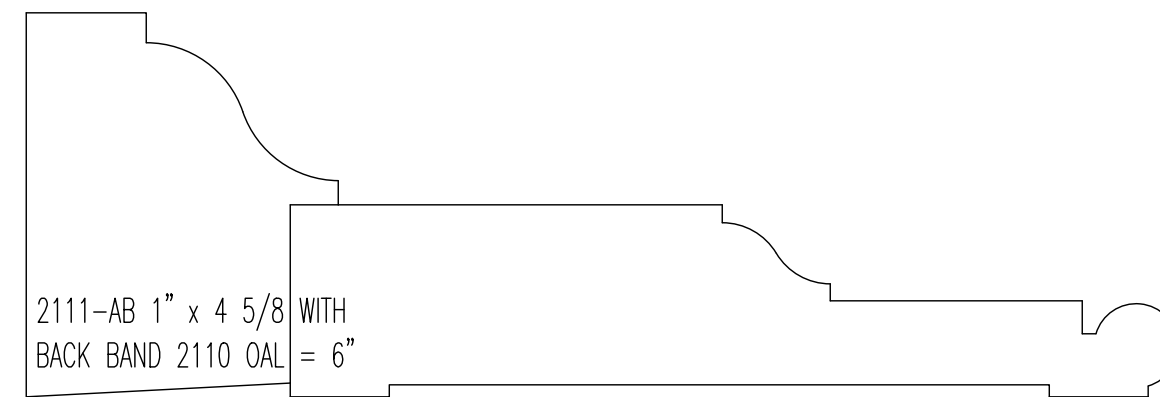
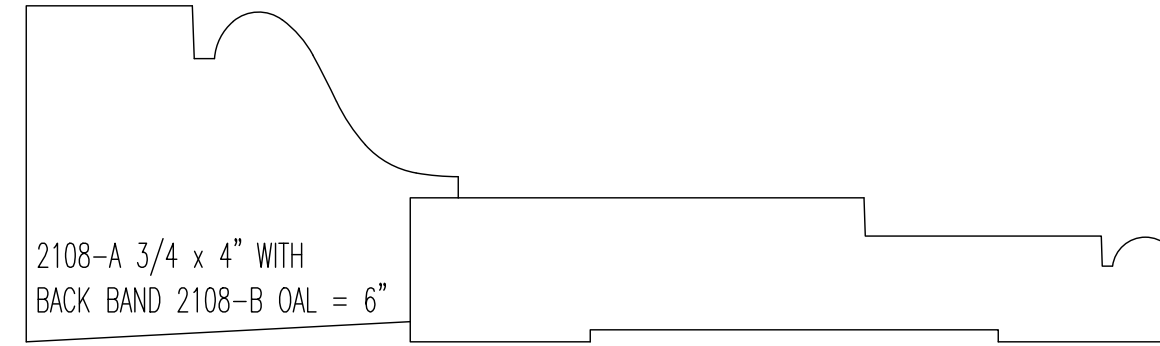
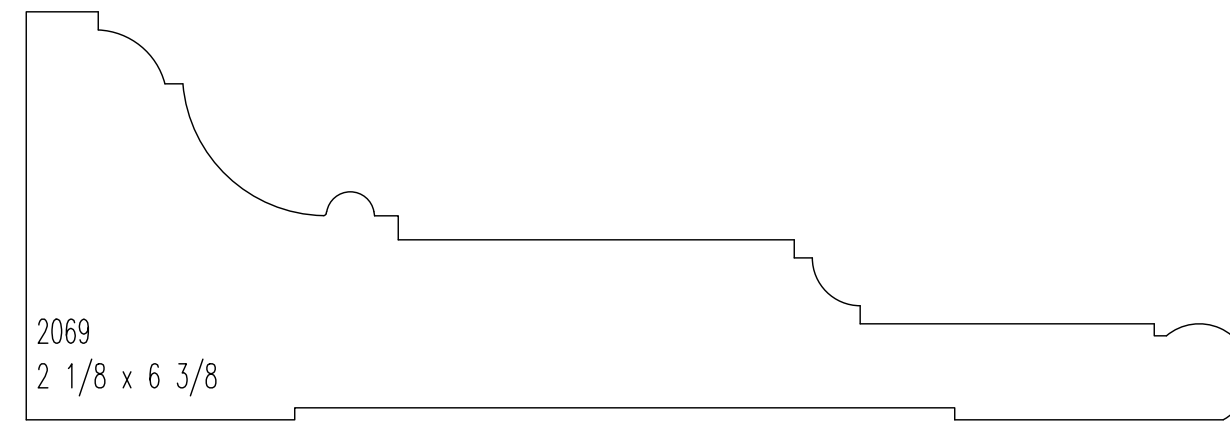
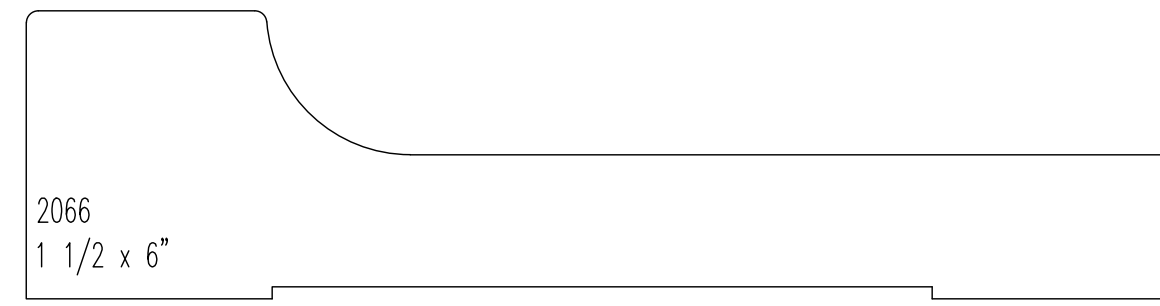

7" CASING

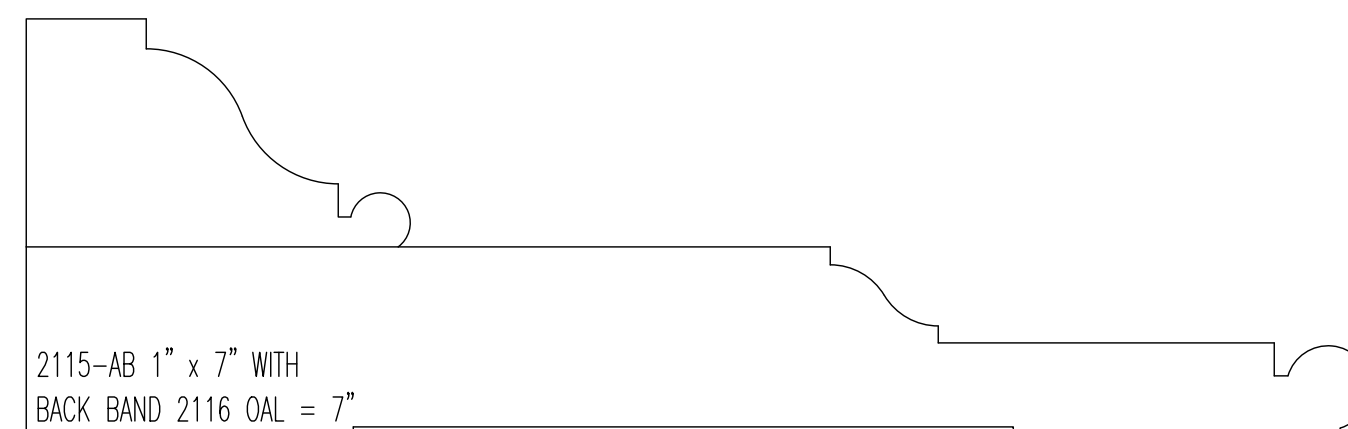

BACK BAND



1" & 2" CROWN





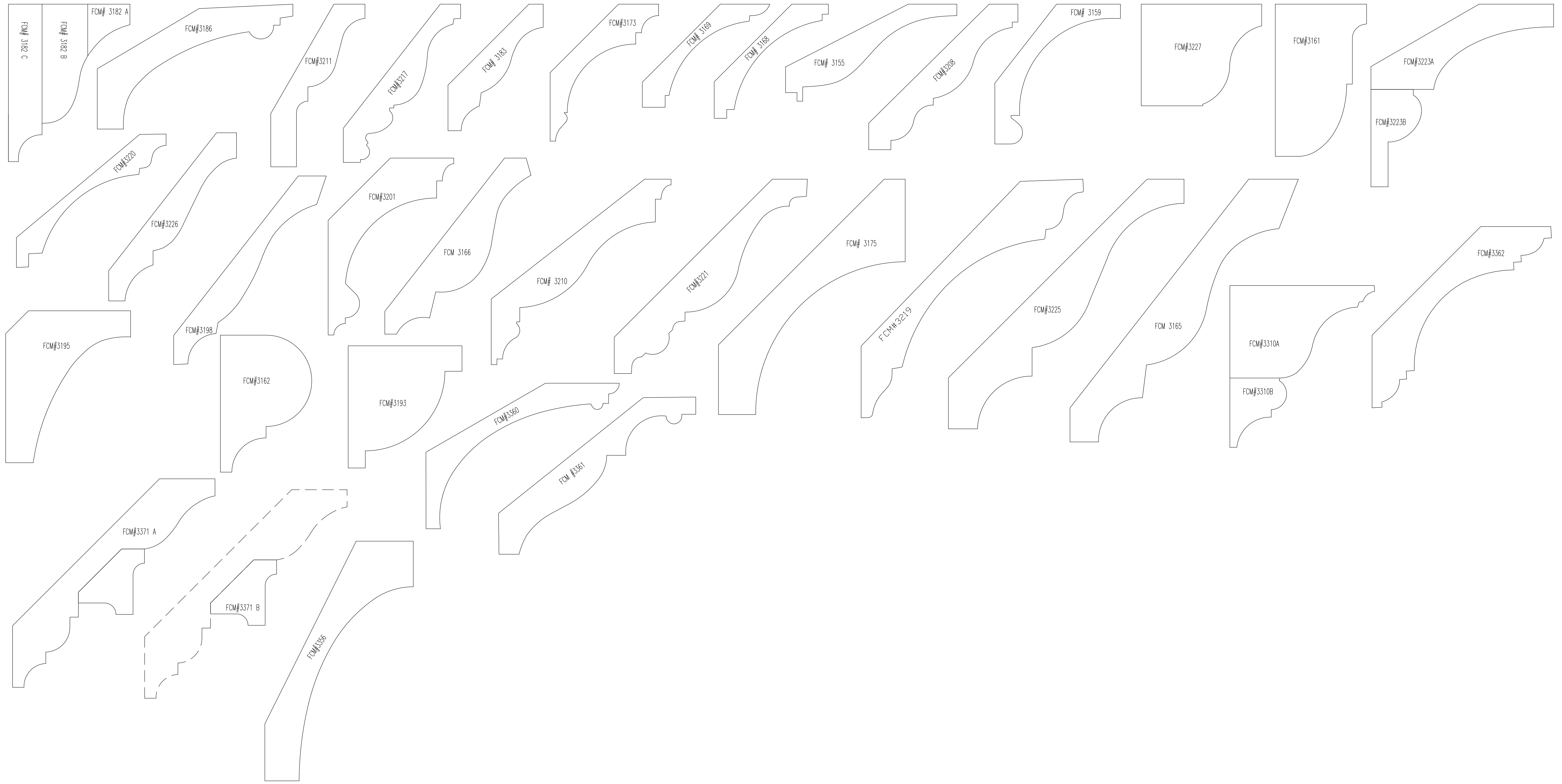

3" CROWN

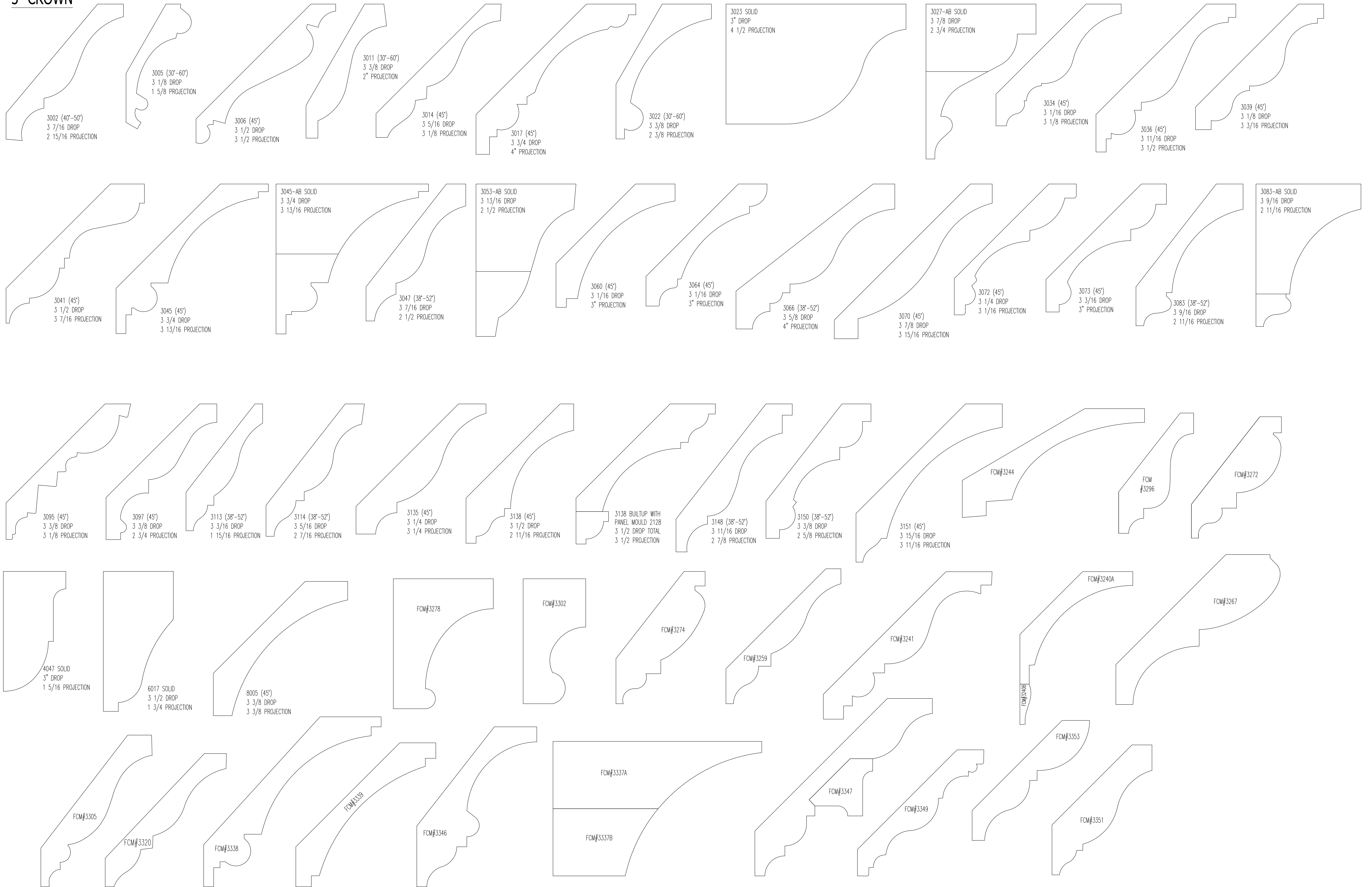

4" DROP & GREATER

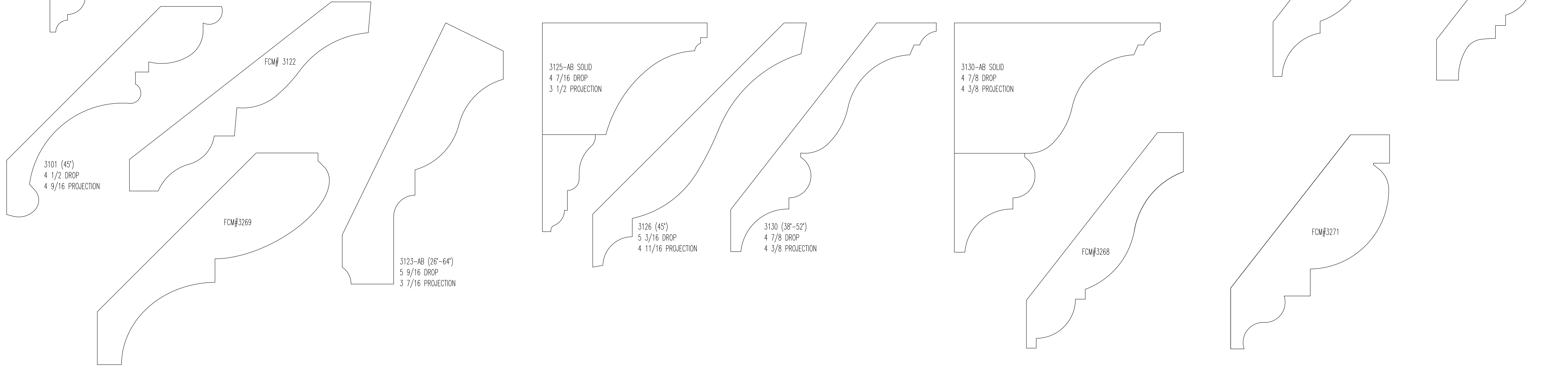
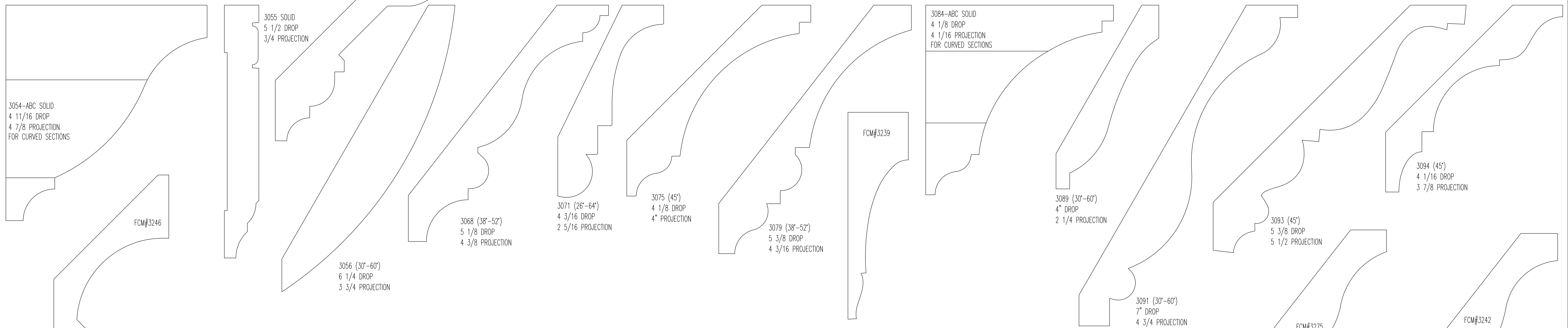
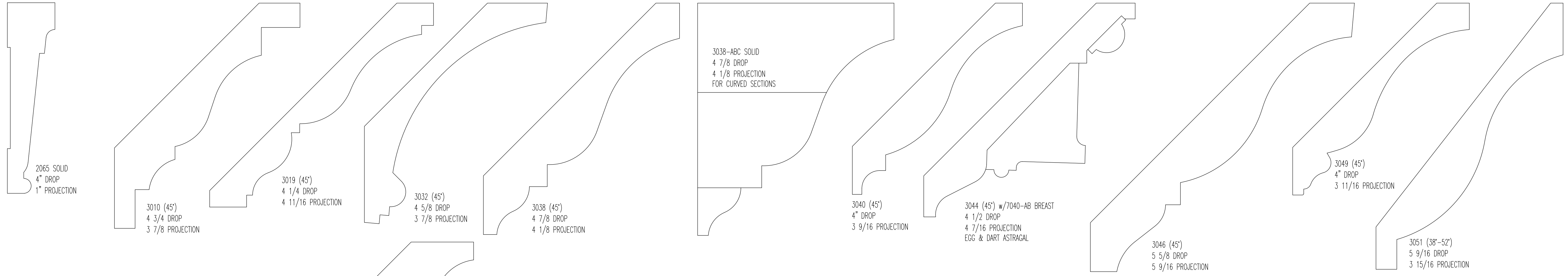

4" DROP & GREATER

3143-ABC SOLID
6 11/16 DROP
6 5/8 PROJECTION

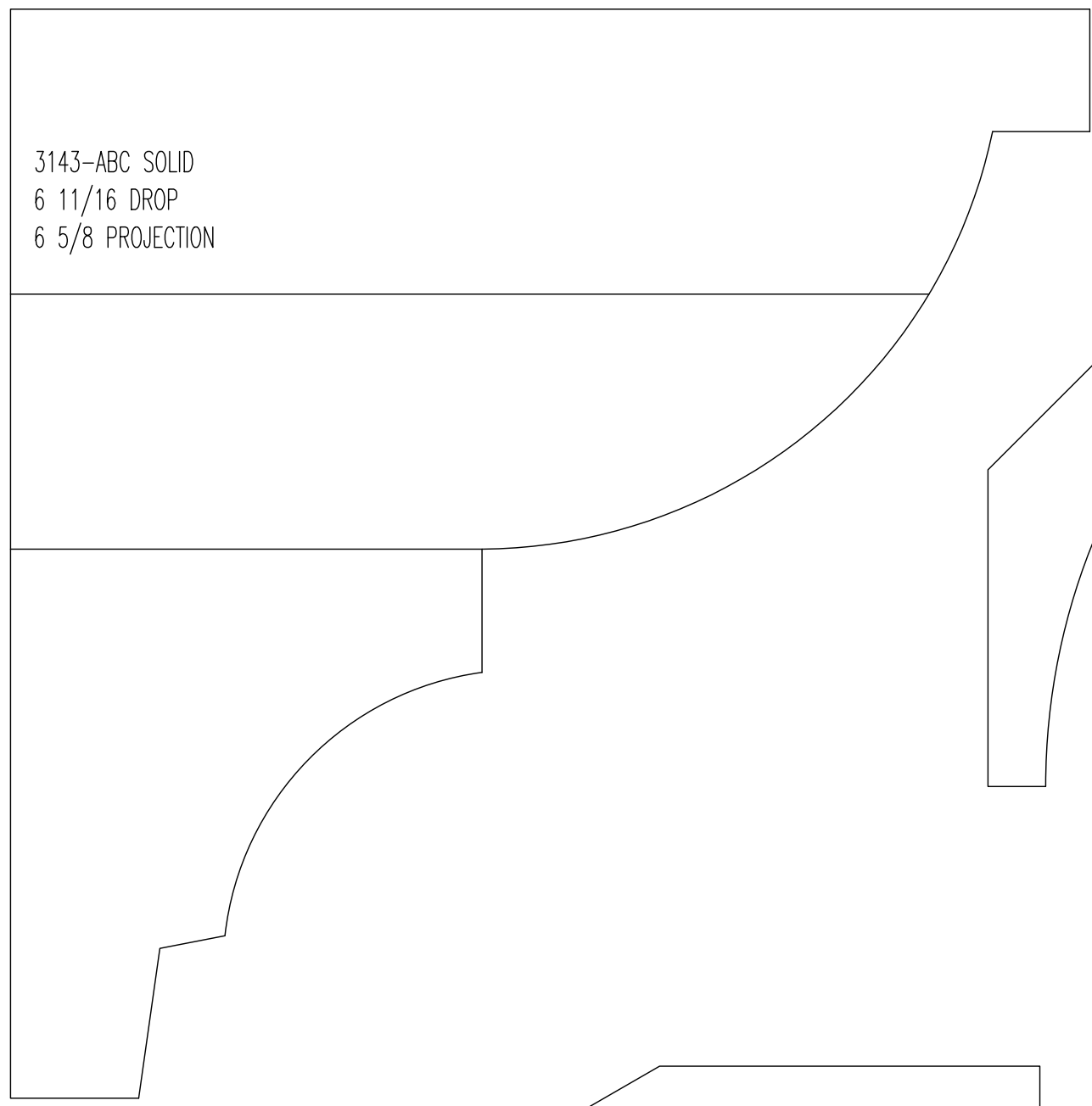

3137 (45°)
4 3/4 DROP
4 5/8 PROJECTION

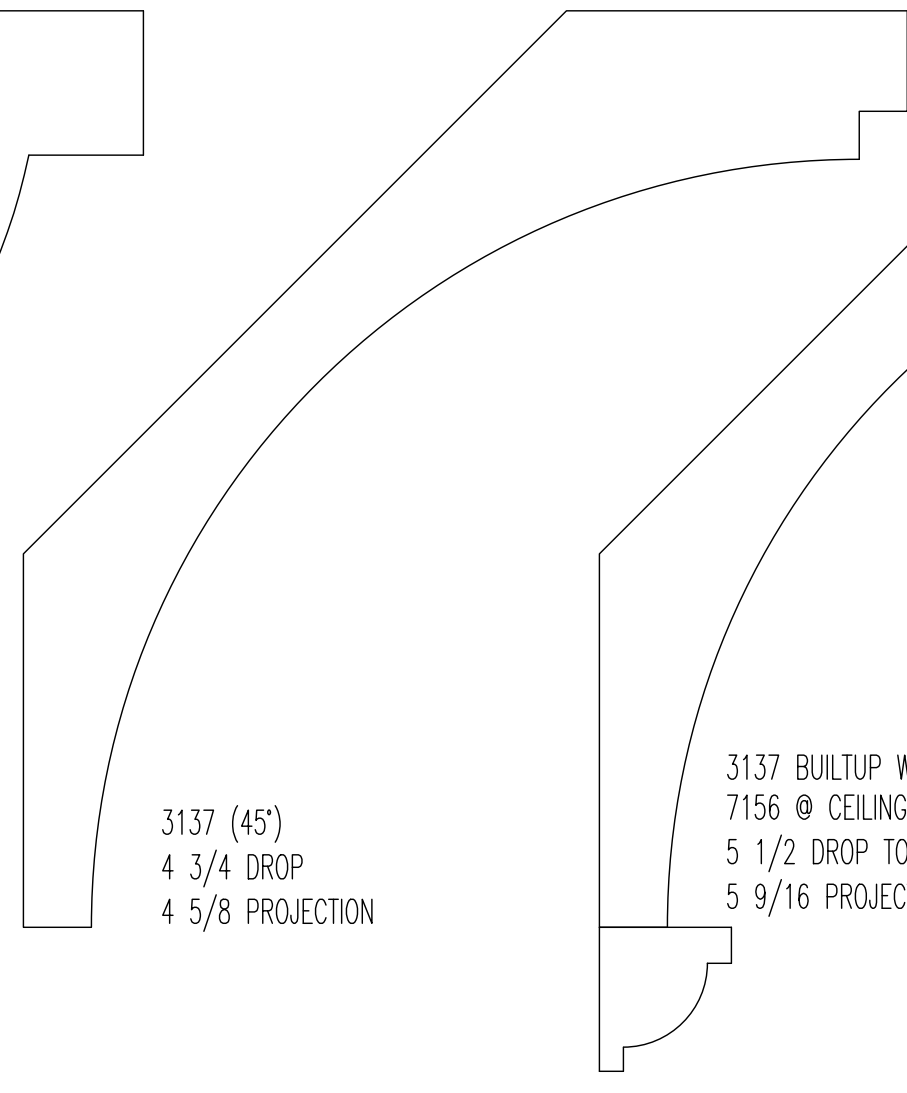

3137 BUILTUP WITH
7156 @ CEILING & 2128 @ BASE
5 1/2 DROP TOTAL
5 9/16 PROJECTION TOTAL

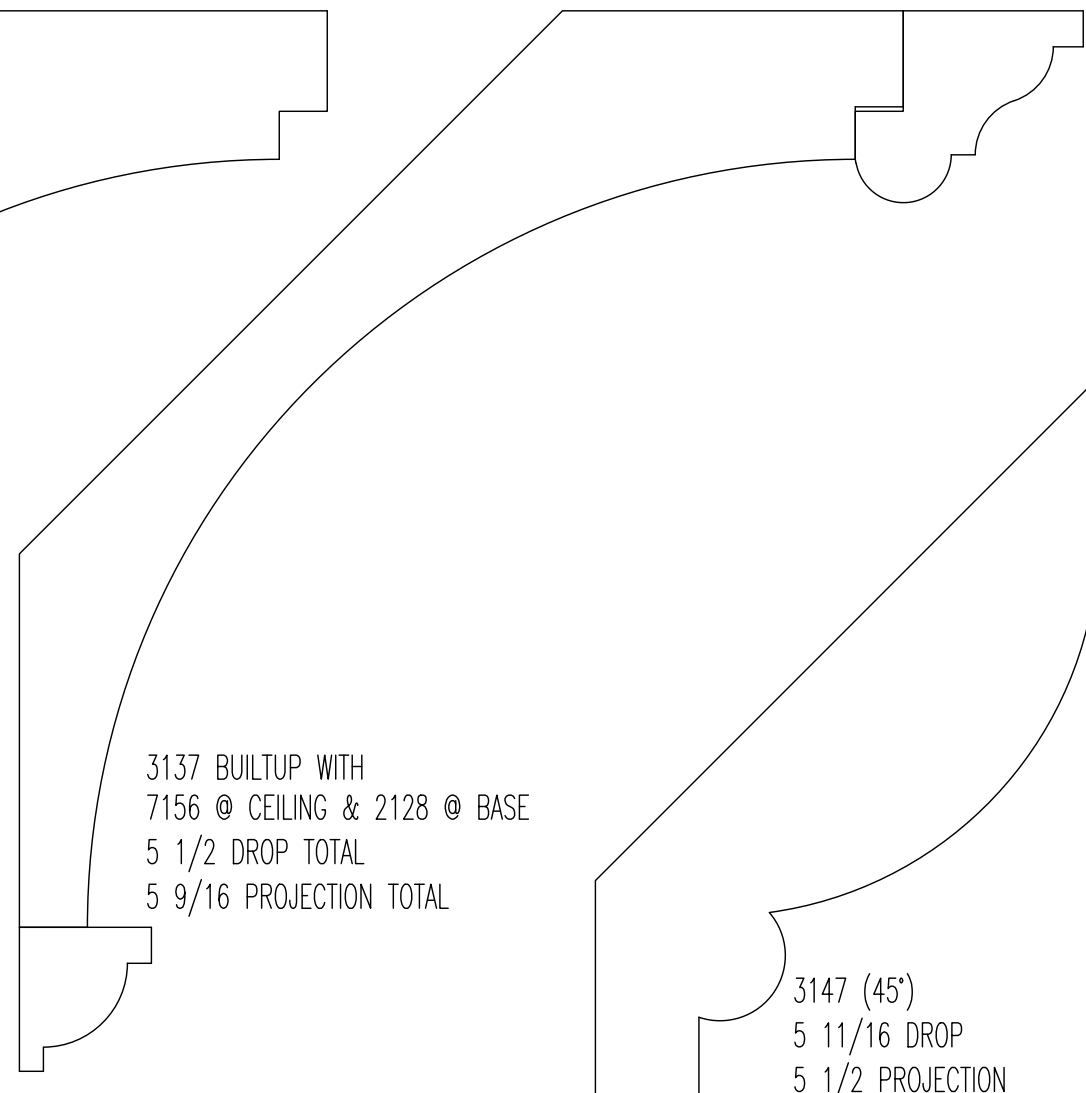

3147 (45°)
5 11/16 DROP
5 1/2 PROJECTION

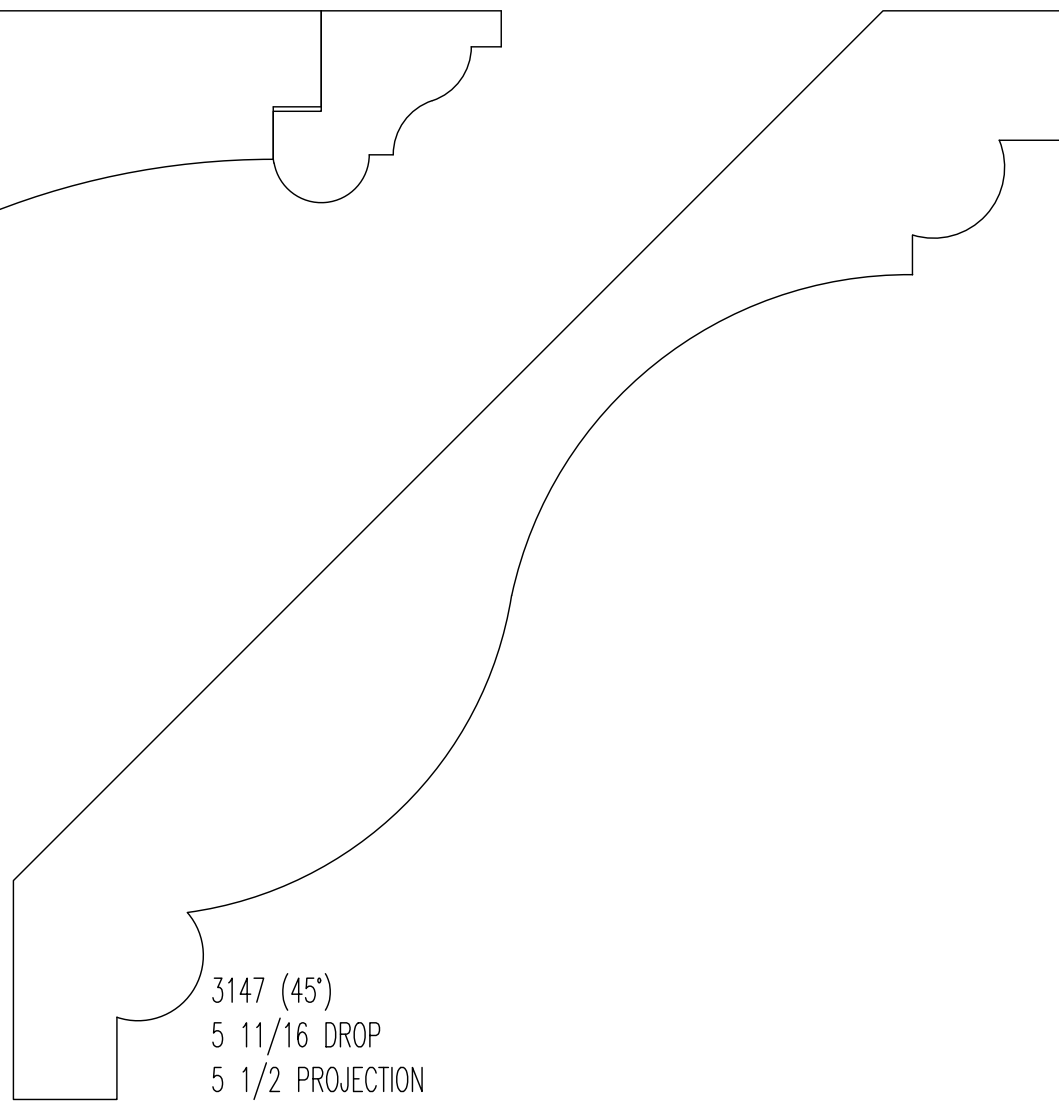

3153 BUILTUP WITH
3152 @ CEILING & 3154 @ BASE
4 3/8 DROP TOTAL
6 1/16 PROJECTION TOTAL

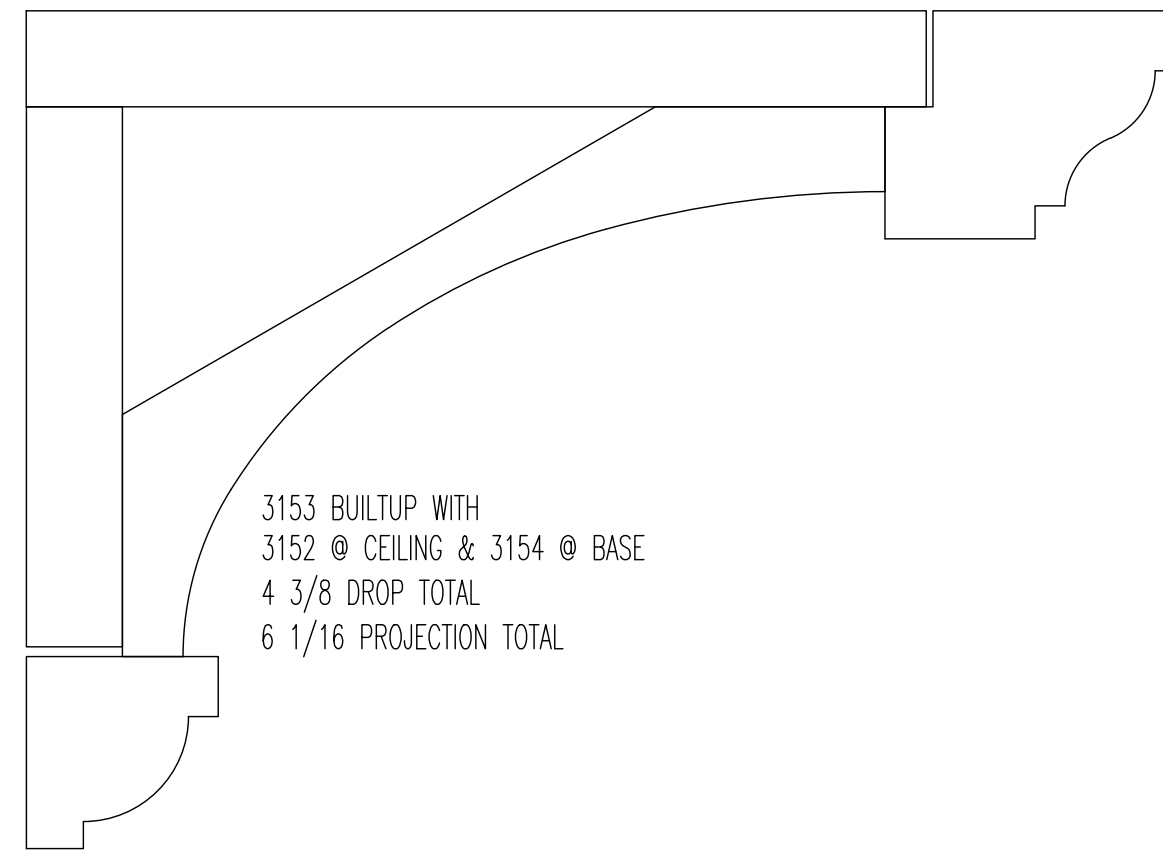

9019 SOLID
4" DROP
2" PROJECTION

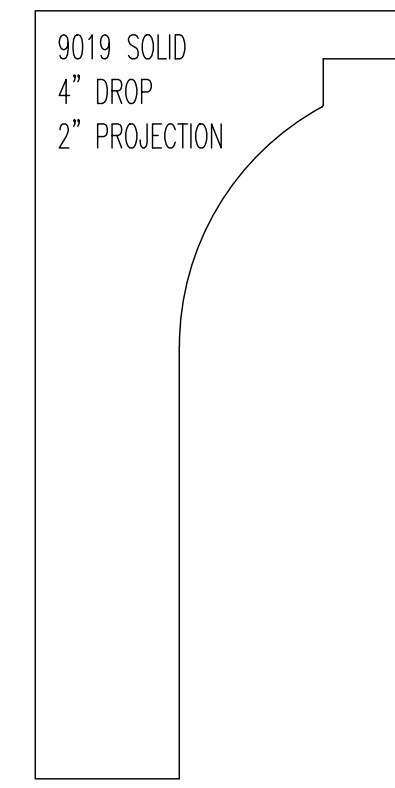

FCM#3273

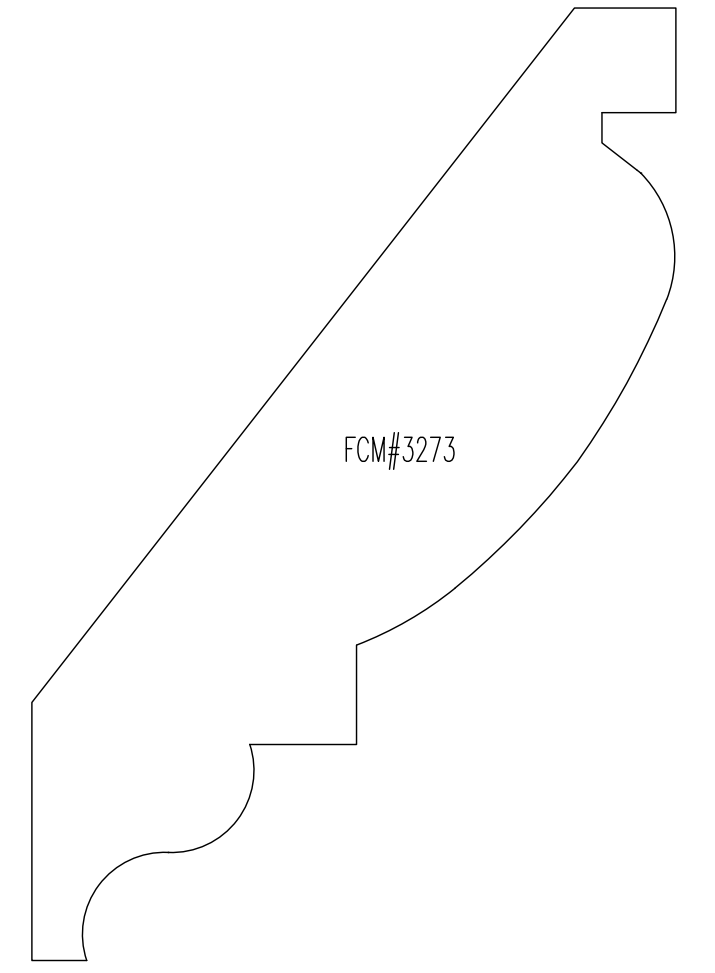

FCM#3199

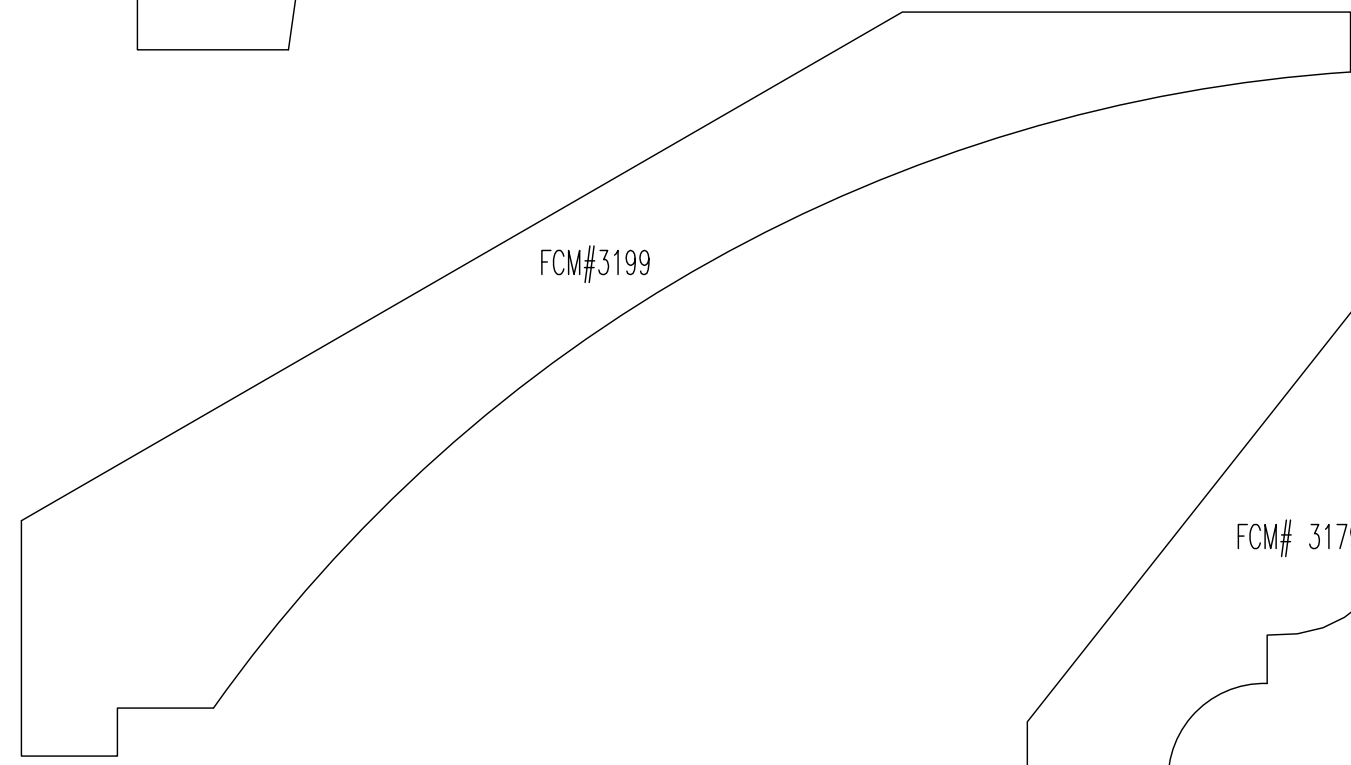

FCM# 3179

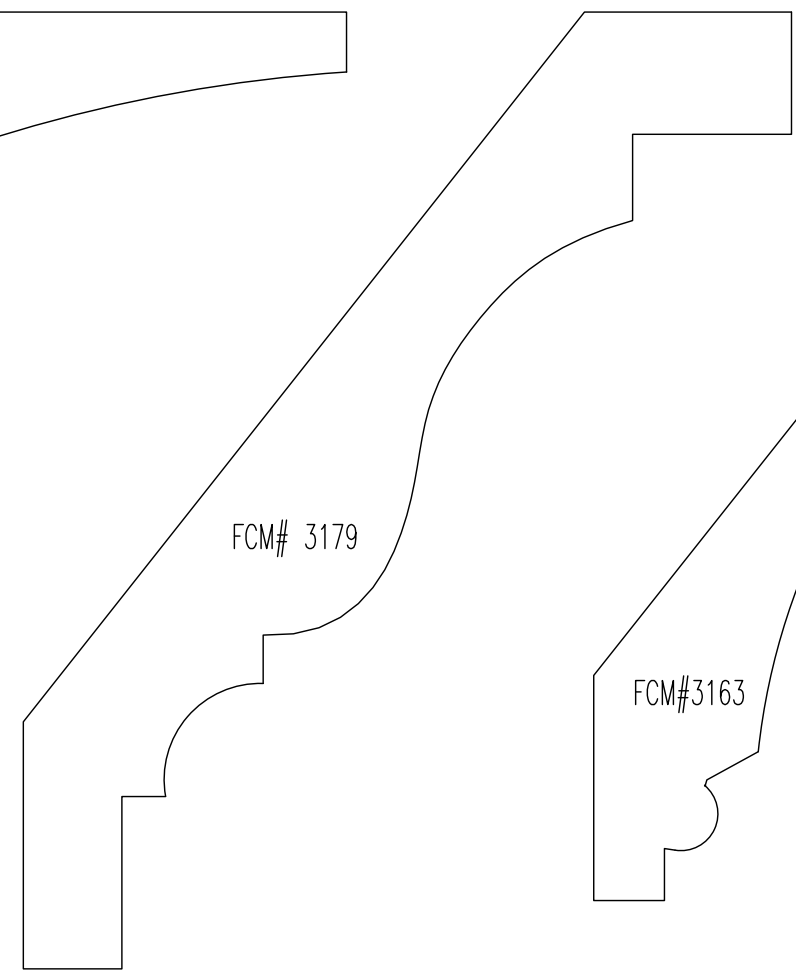

FCM#3163

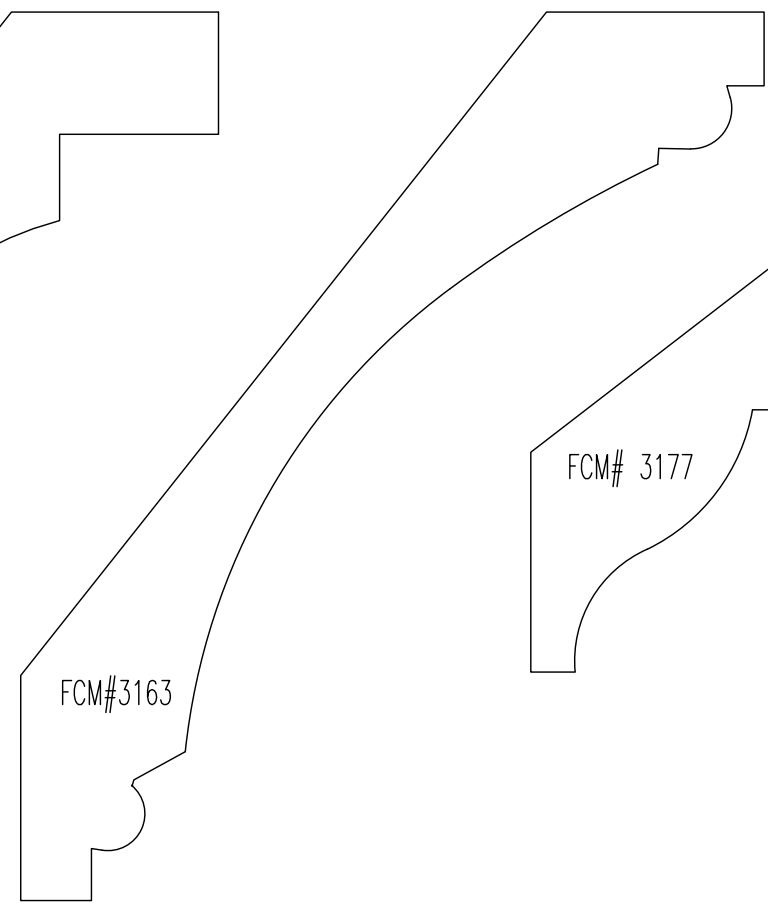

FCM# 3177

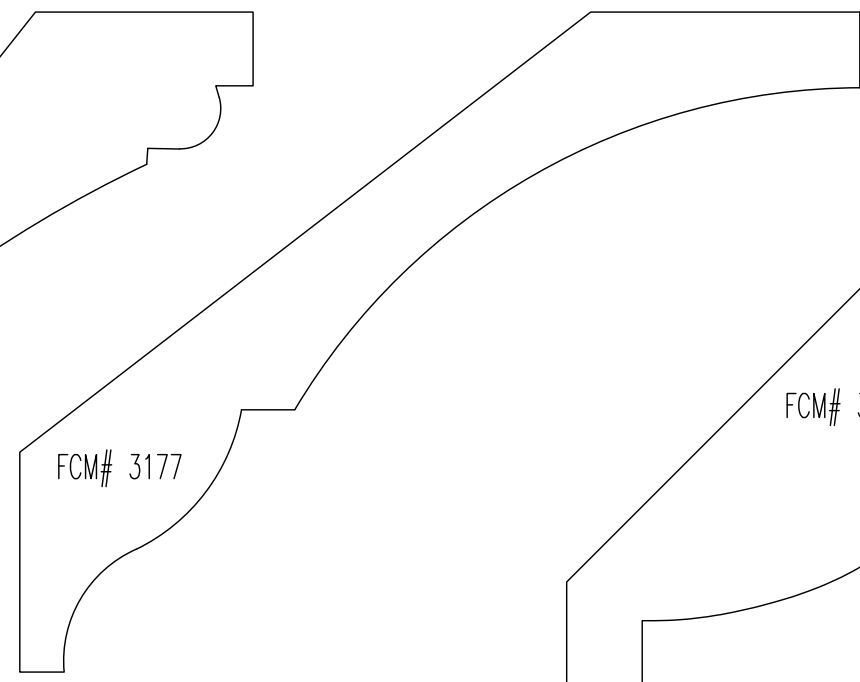

FCM# 3156

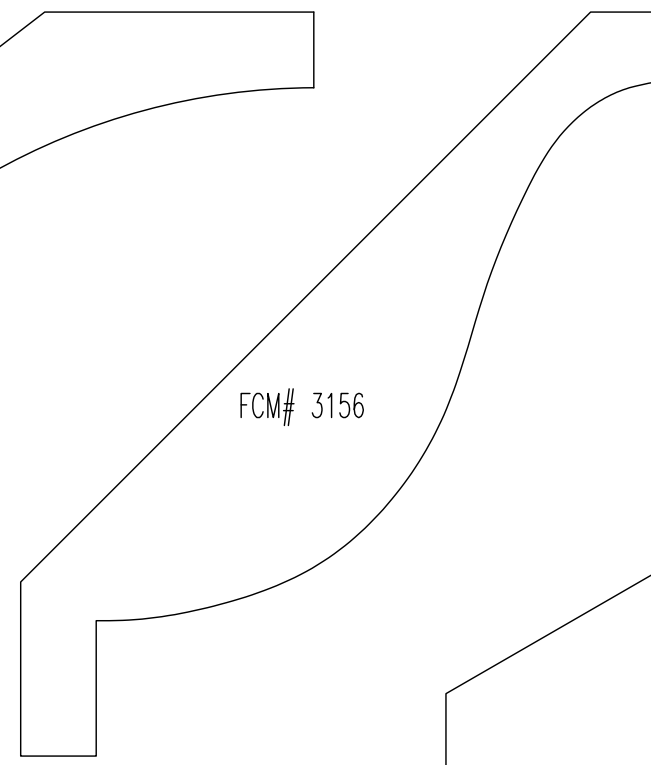

FCM#3196-A

FCM#3196-B

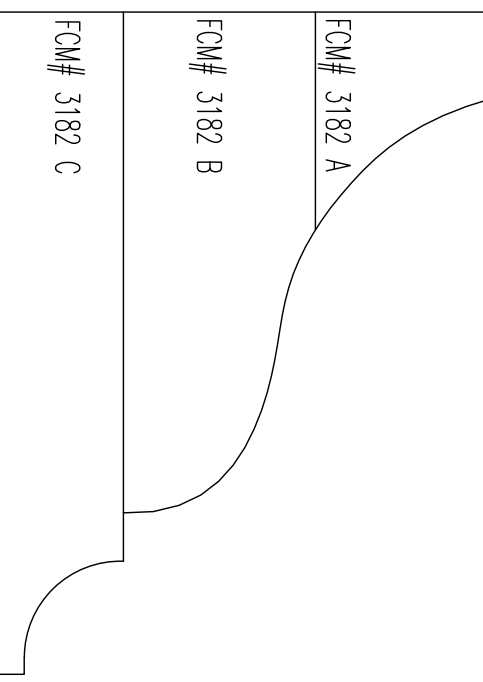
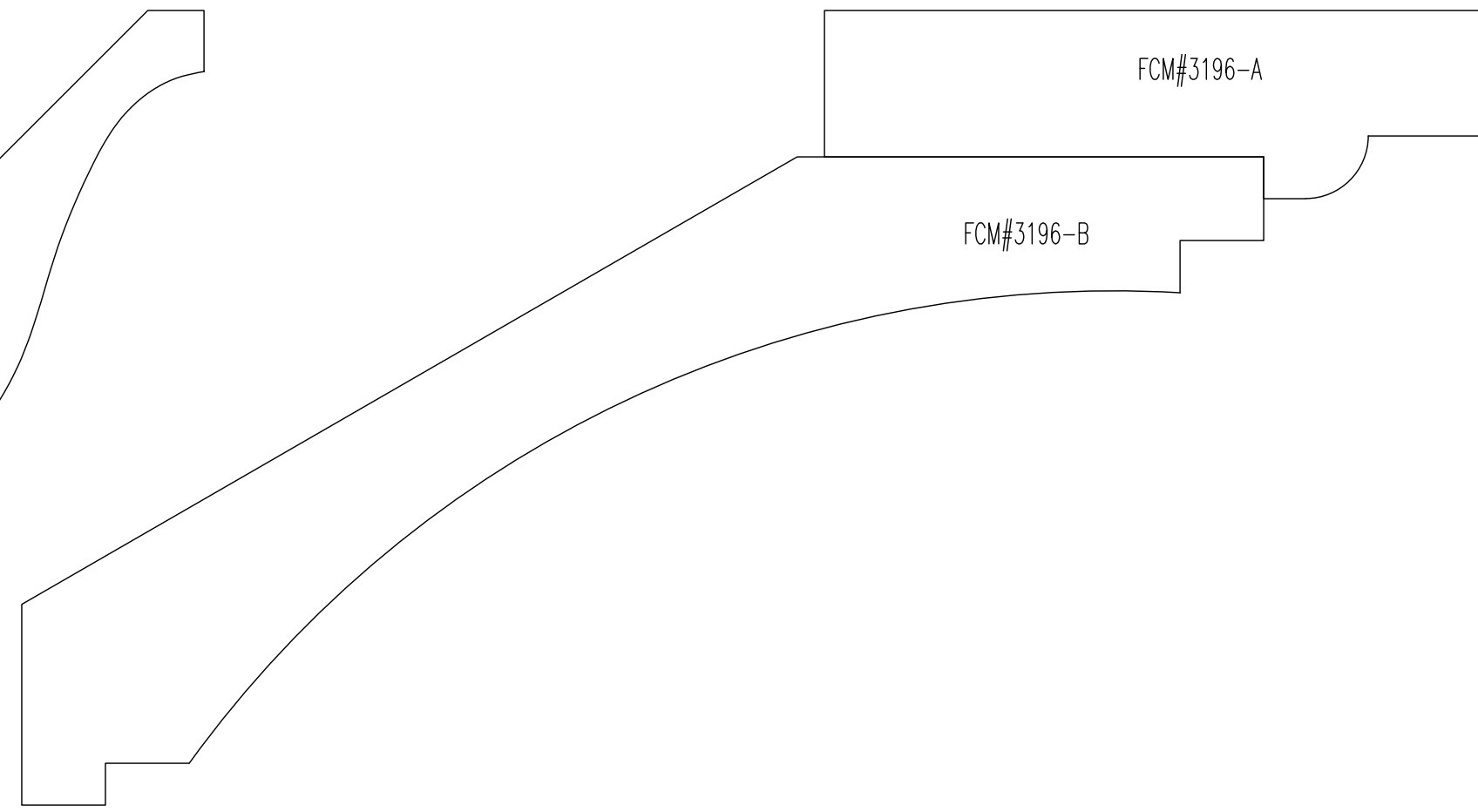

FCM# 3182 C

FCM# 3182 B

FCM# 3182 A

"A"

CROWN 1

FCM# 3181

"B"

"C"

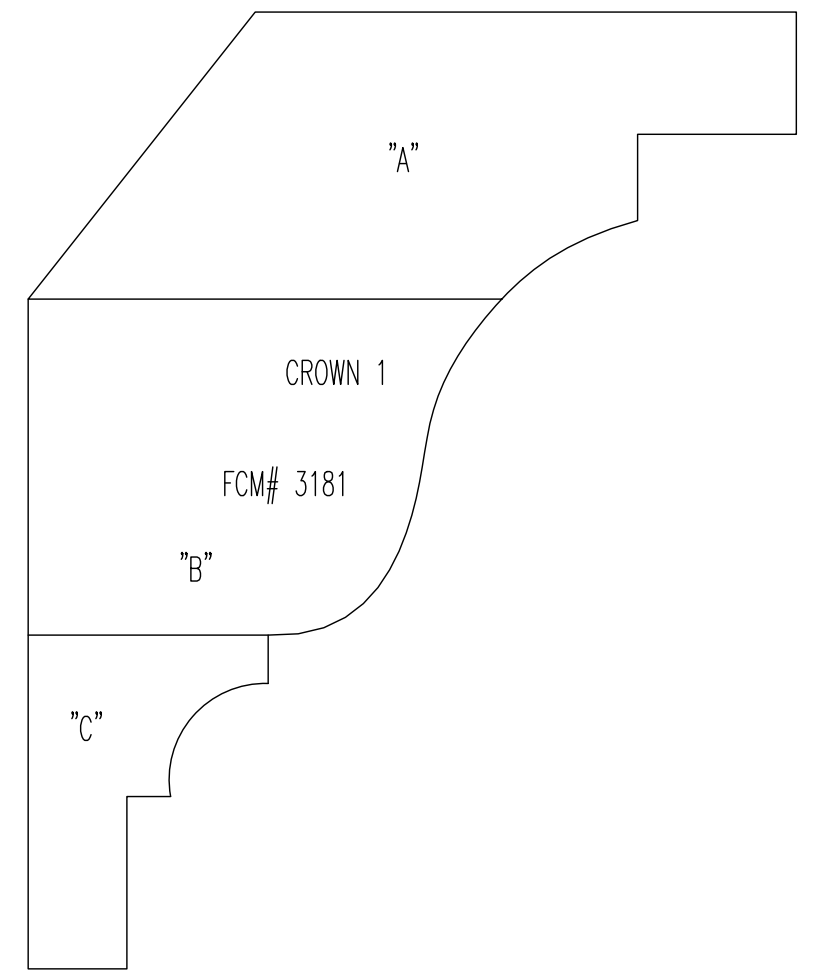

FCM#3218

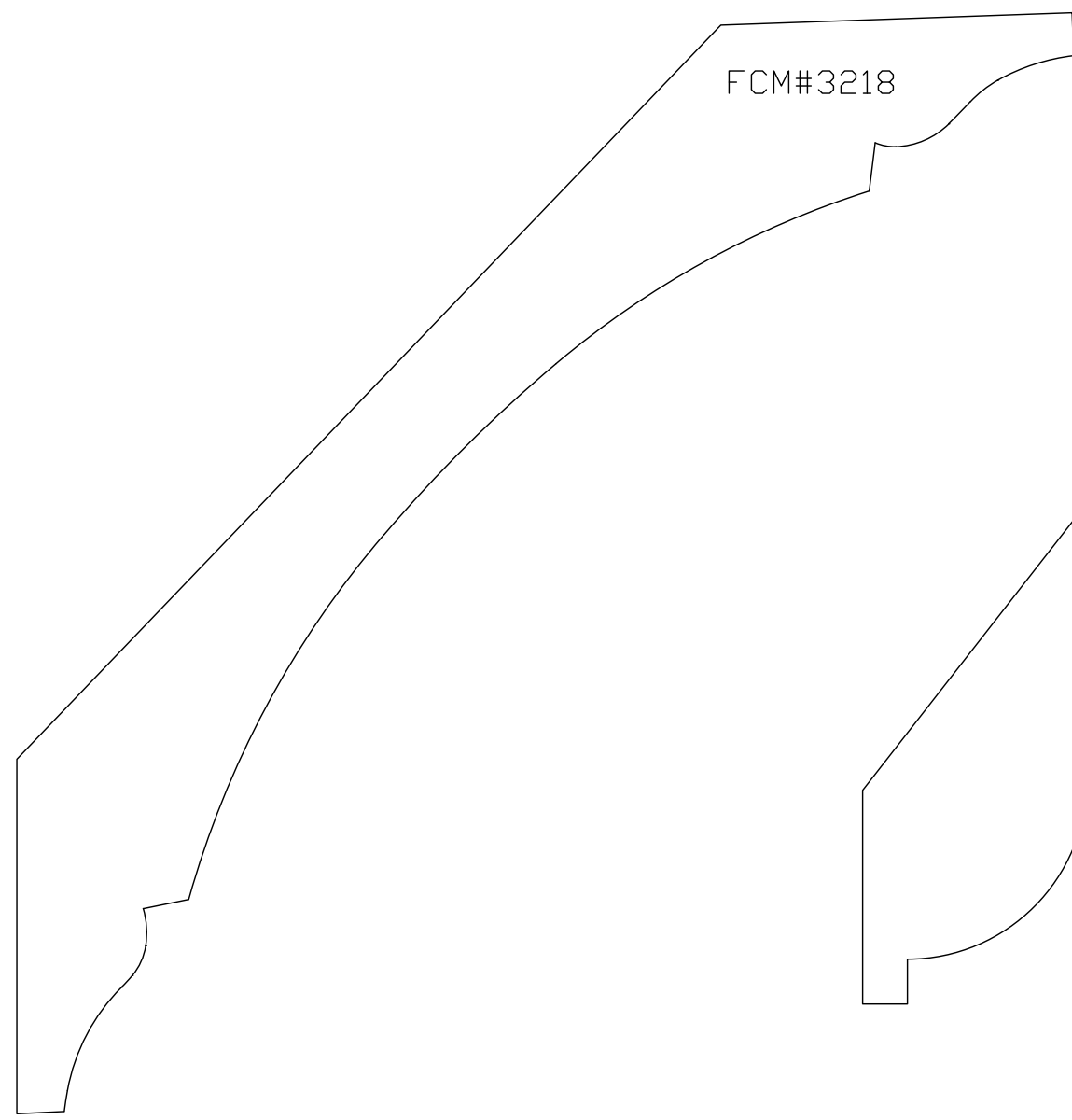

FCM#3270

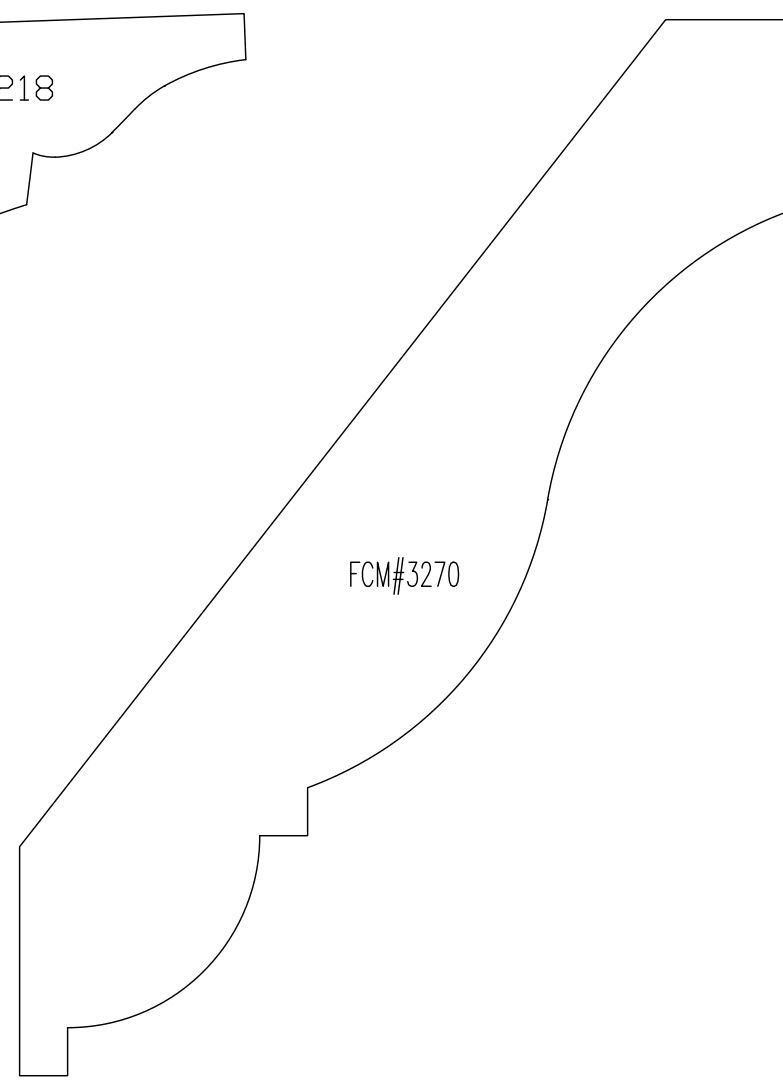

FCM#3245

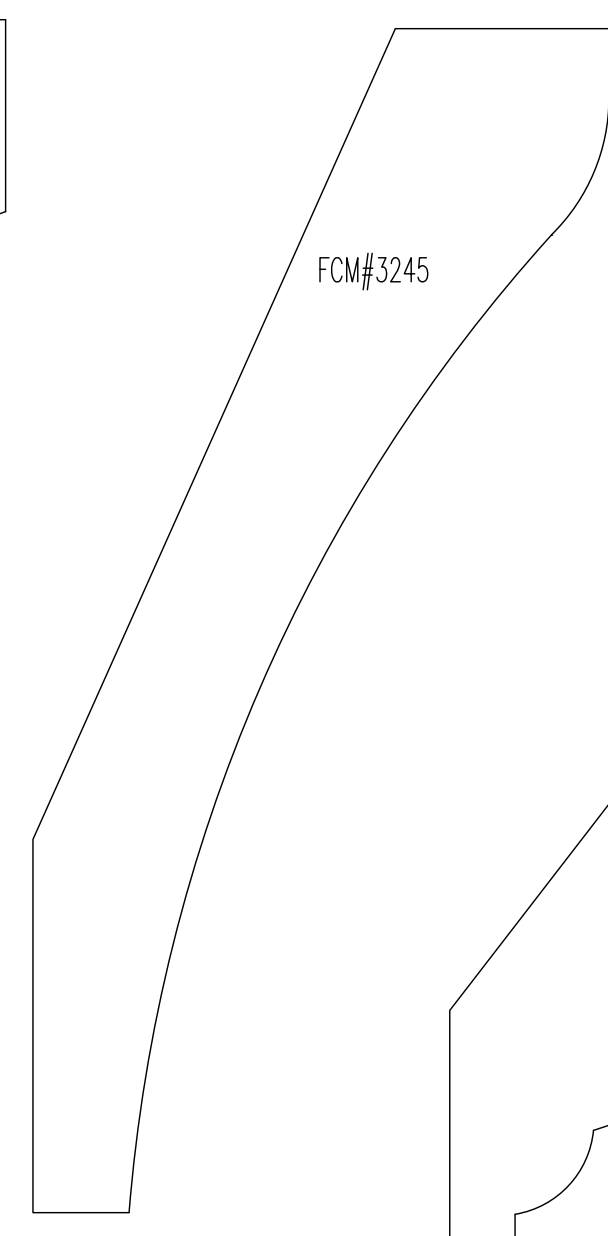

FCM#3354



FCM#3331

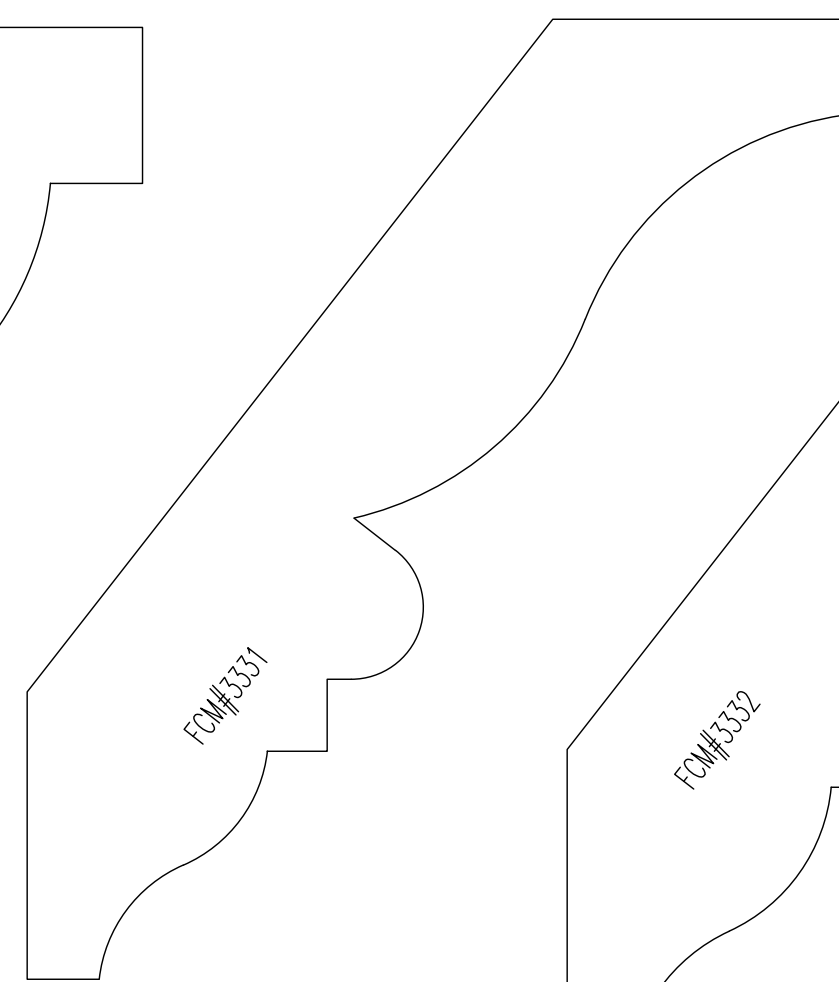

FCM#3332

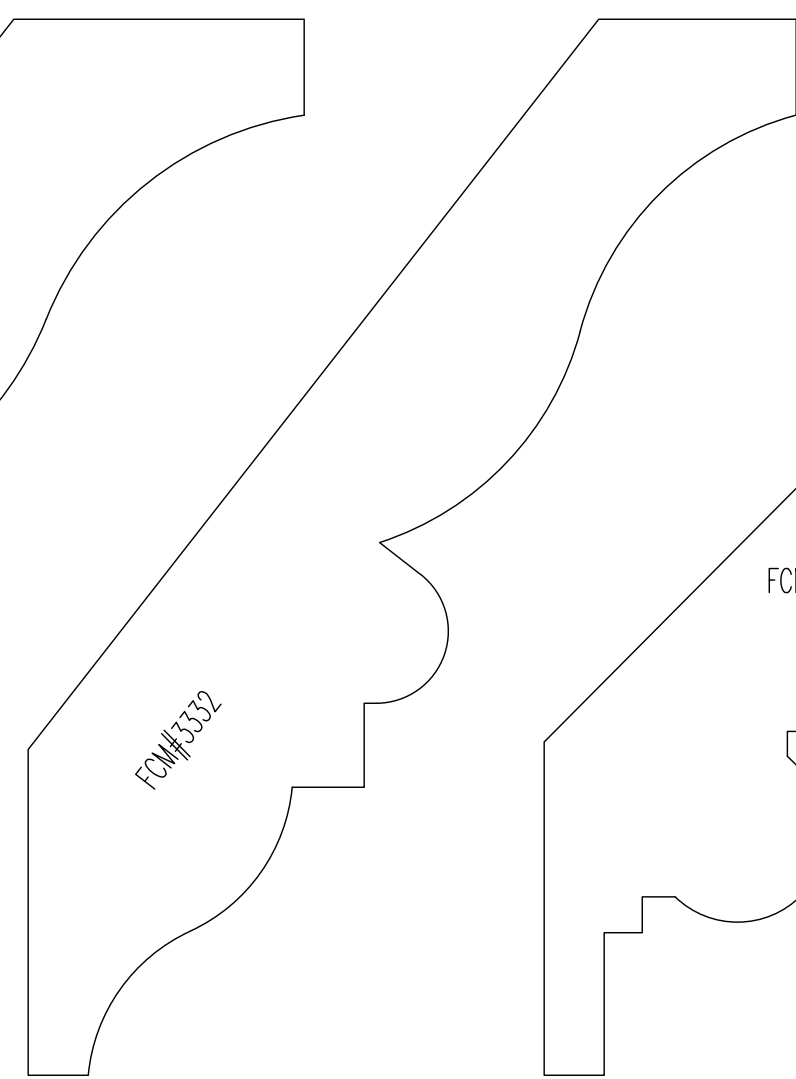

FCM#3323

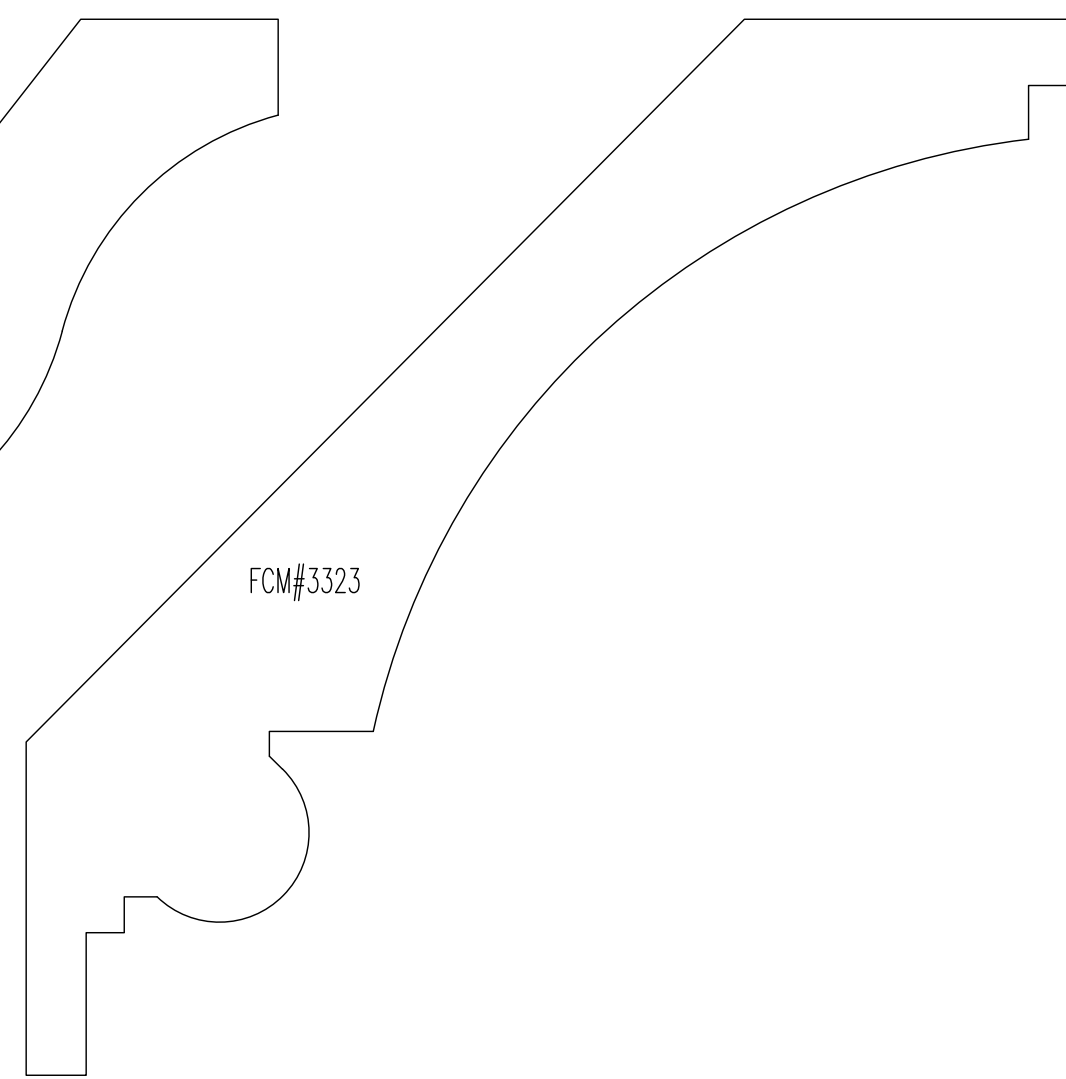

3/4" EDGE

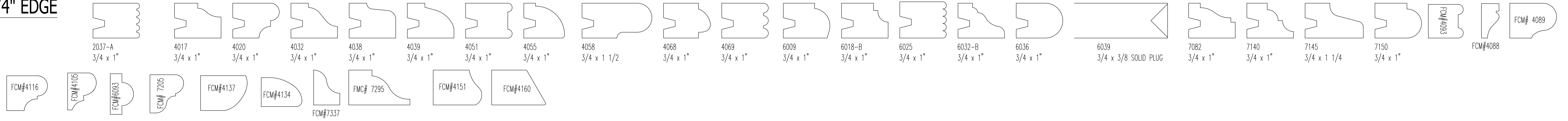

1" EDGE

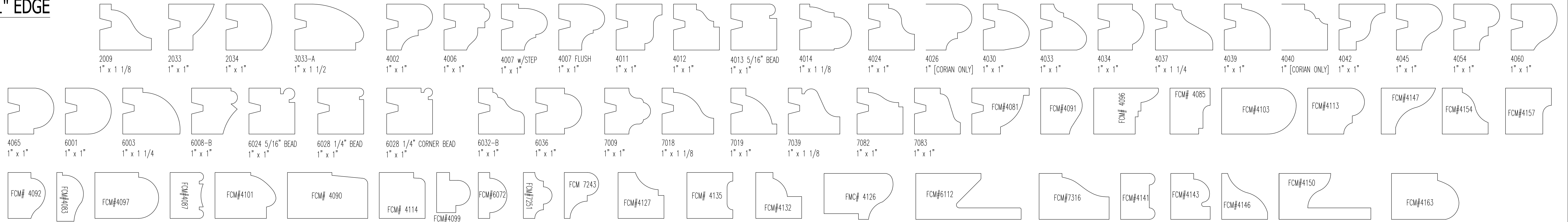

1 1/8" EDGE

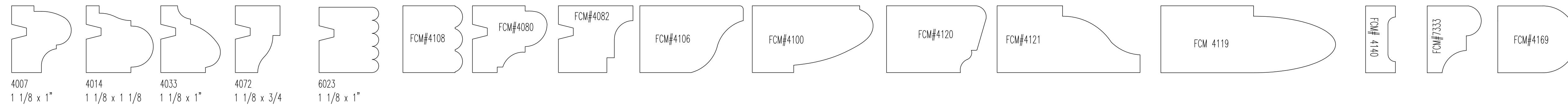

1 1/4" EDGE

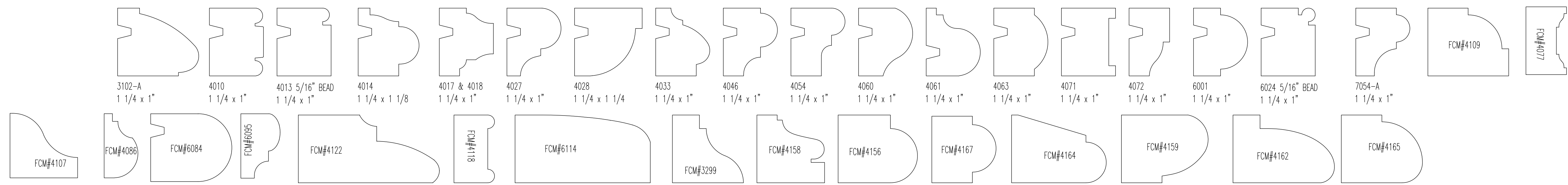

1 3/8" EDGE

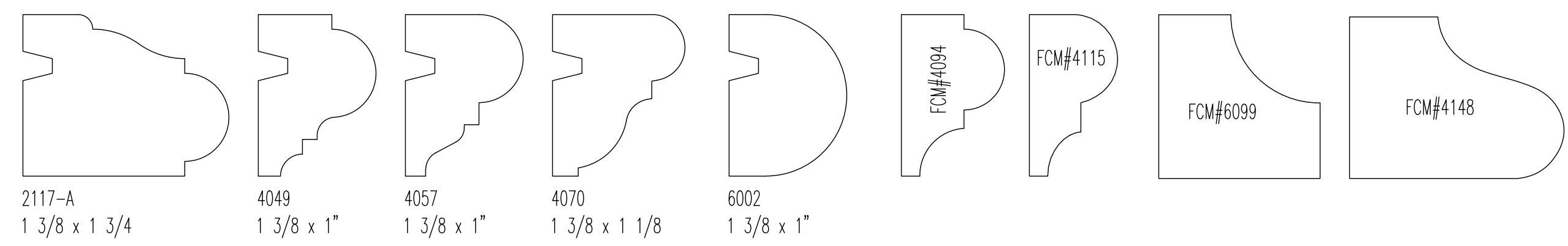

MISC EDGES

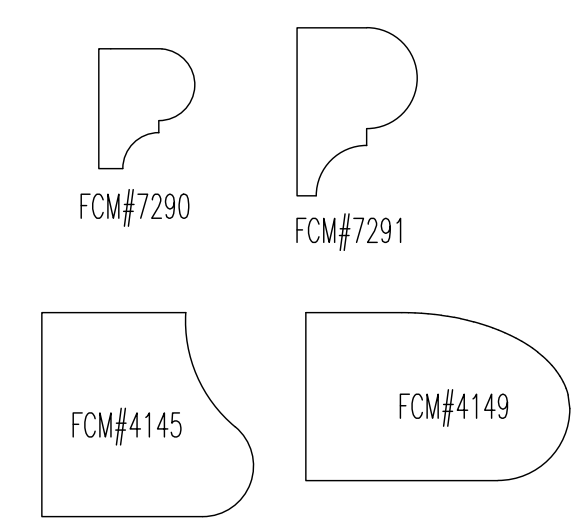

1 1/2" EDGE

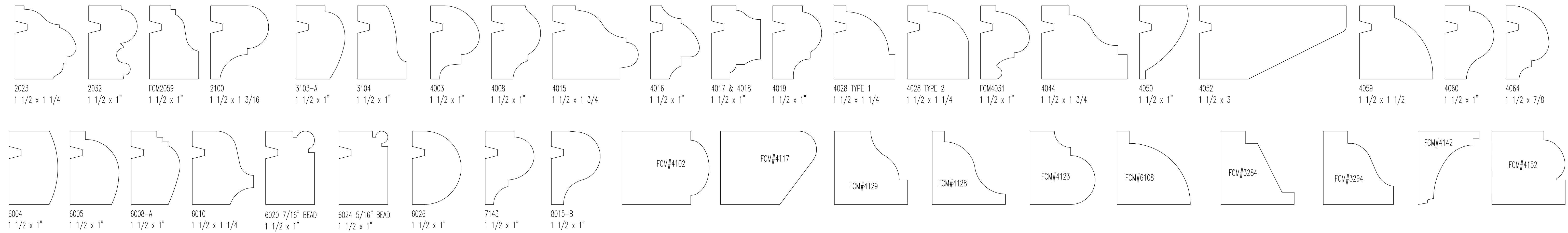

1 5/8" EDGE

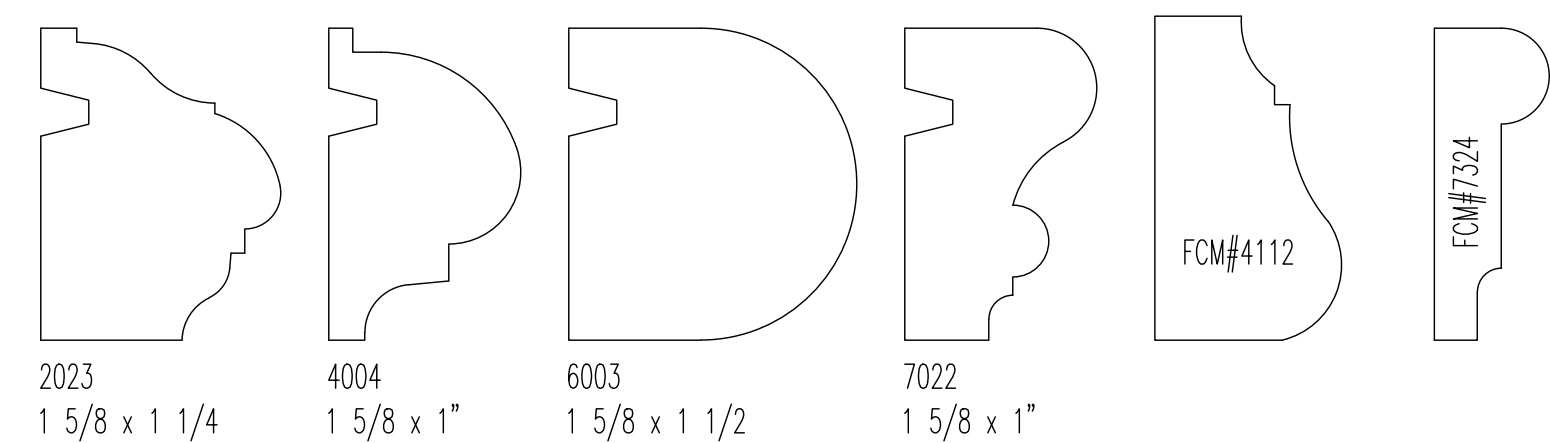

1 3/4" EDGE

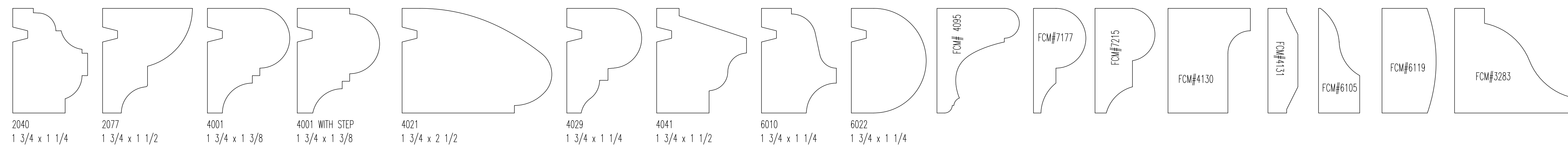

1 7/8" EDGE

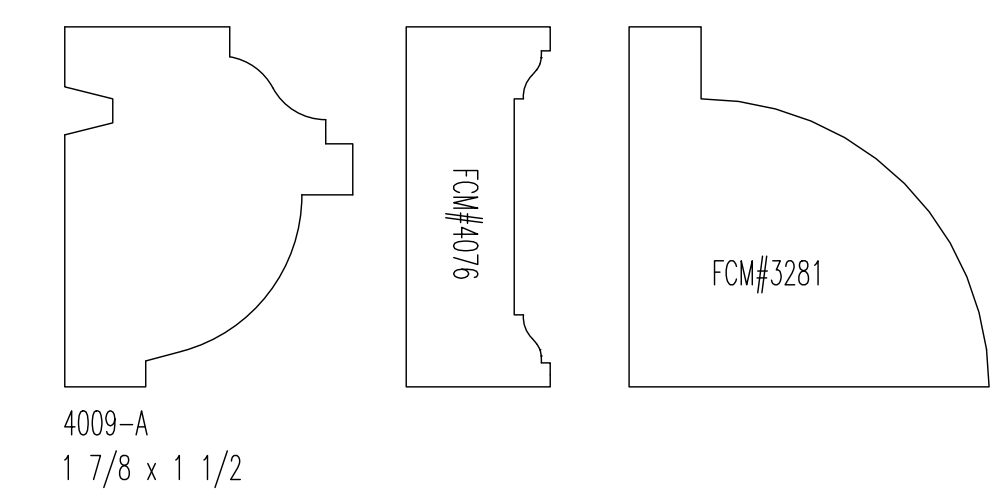

2" EDGE

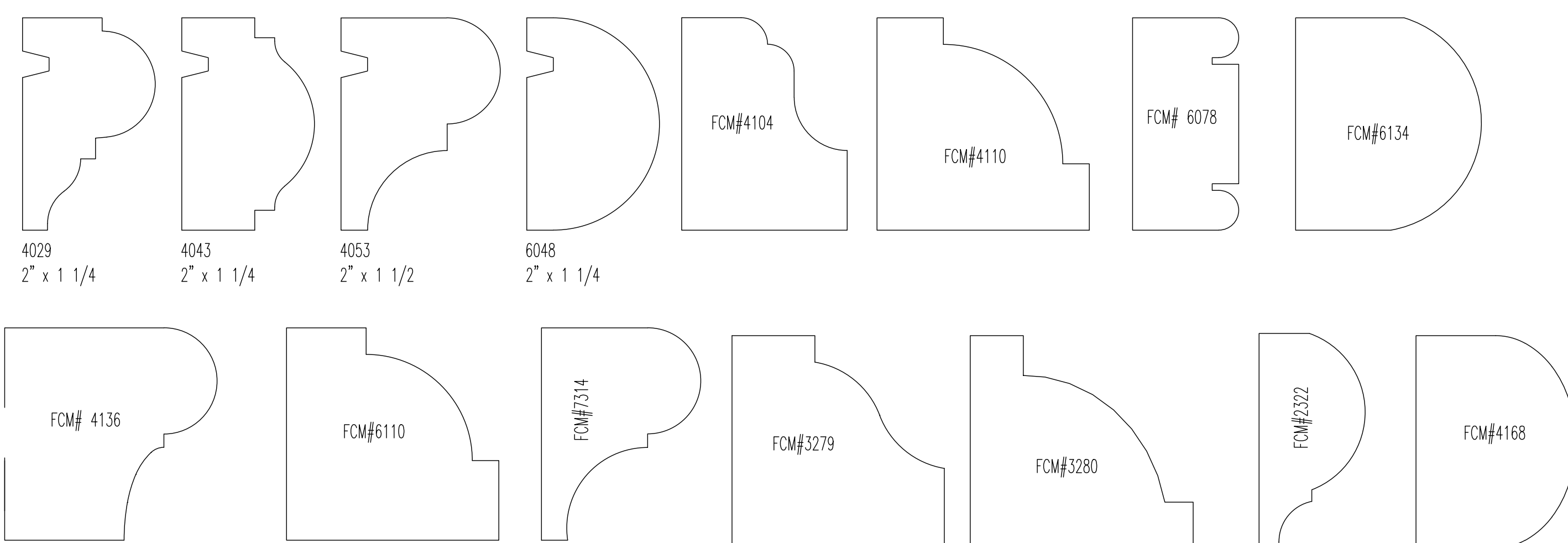

2 1/4" EDGE

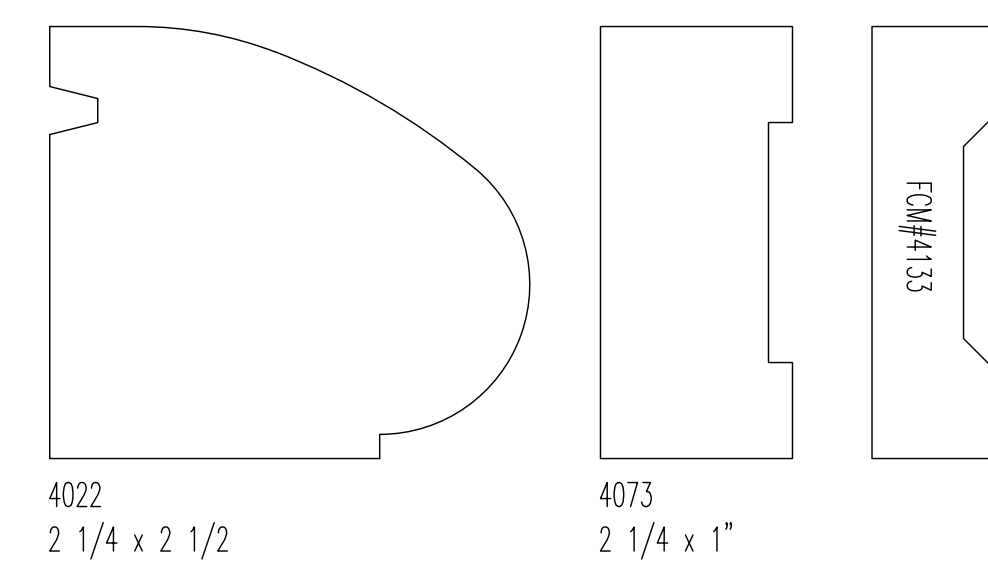

2 1/2" EDGE

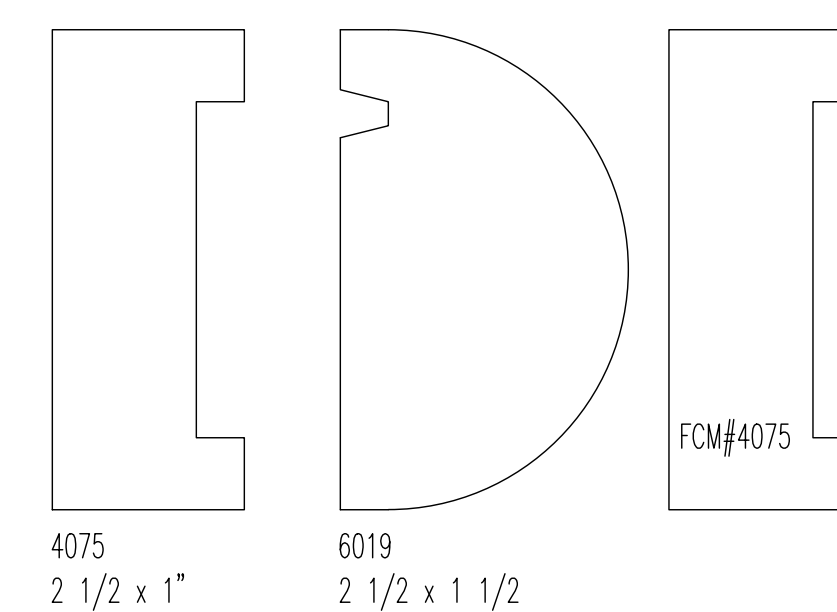

2 3/4" EDGE

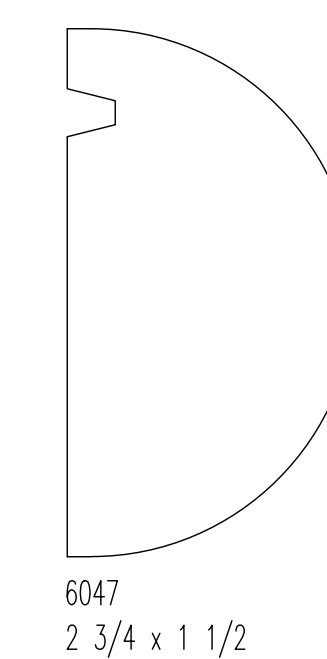

3 1/2" EDGE

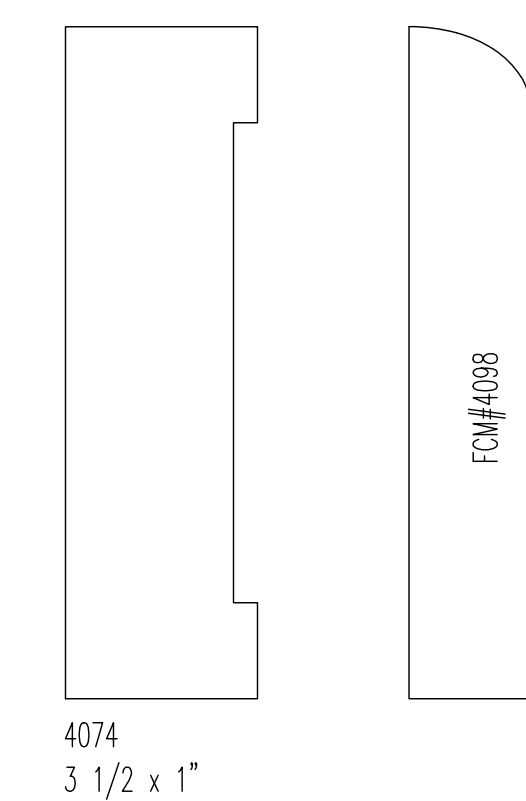

SOLID STICK EDGE

1012 1/4 STICK EDGE x 3/8 RECESS 5/8 TONGUE	1055-AB 1/4 STICK EDGE x 9/16 RECESS 5/8 TONGUE	7070-AB 9/32 SHAKER EDGE x 3/8 RECESS 9/16 TONGUE ** MINIMUM DOOR 1 1/4	FCM#1097	FCM#1120
1025-AB 9/16 STICK EDGE x 1/2 RECESS 5/8 TONGUE	1058-AB 3/8 STICK EDGE x 3/8 RECESS 3/4 TONGUE	7070-B 3/8 RECESS 9/16 TONGUE ** MINIMUM DOOR 1 1/4	FCM#1098	FCM#1121
1026 3/8 STICK EDGE x 7/16 RECESS 5/8 TONGUE	1059-AB 7/16 STICK EDGE x 1/2 RECESS 5/8 TONGUE	1085-AB STILE/RAIL	FCM#1099	FCM#1124B
1027 3/8 STICK EDGE x 3/8 RECESS 5/8 TONGUE	1061-AB 1/2 STICK EDGE x 1/2 RECESS 3/4 TONGUE ** SAME AS 7050 PANEL MOULD	1086-AB STILE/RAIL	FCM#1100	FCM#1125
1028 3/8 STICK EDGE x 3/8 RECESS 5/8 TONGUE	1063-AB 1/4 STICK EDGE x 9/16 RECESS 5/8 TONGUE	1087-AB STILE/RAIL	FCM#1101	FCM#1126A
1033-AB 3/8 STICK EDGE x 1/2 RECESS 3/8 TONGUE	1065-AB	1088-AB STILE/RAIL	FCM#1106	FCM#1127A
1034-AB 1/4 STICK EDGE x 1/4 RECESS 5/8 TONGUE	1067 3/8 STICK EDGE x 1/2 RECESS 5/8 TONGUE	FCM# 1089	FCM#1107	
1035-AB 1/8 STICK EDGE x 1/2 RECESS 5/8 TONGUE	FCM# 1068	FCM# 1090	FCM#1109	
1037-AB 5/16 STICK EDGE x 3/8 RECESS 5/8 TONGUE	1069-AB ** MINIMUM DOOR 1 1/8 11/16 STICK EDGE x 21/32 RECESS 5/8 TONGUE ** SAME AS 7126 PANEL MOULD	FCM# 1091	FCM# 1110	
1037-AB 5/16 STICK EDGE x 7/16 RECESS 5/8 TONGUE	1075-AB "SHAKER" STYLE x 1/4 RECESS 5/8 TONGUE	FCM#1092	FCM#1112	
1038-AB 7/16 STICK EDGE x 1/2 RECESS 5/8 TONGUE	1075-AB "SHAKER" STYLE x 3/8 RECESS 5/8 TONGUE	FCM#1093	FCM#1113	
1040-AB 3/8 STICK EDGE x 1/2 RECESS 5/8 TONGUE	1076 [MITERED JOINERY] 1/2 STICK EDGE x 1/2 RECESS 3/8 TONGUE	FCM#1094	FCM#1114	
1041-AB 7/8 STICK EDGE x 1/2 RECESS 5/8 TONGUE	1077-AB 1/2 STICK EDGE x 3/8 RECESS 5/8 TONGUE	FCM#1095	FCM#1115	
1043-AB 1/4 STICK EDGE x 3/8 RECESS 5/8 TONGUE	1080-AB 3/8 STICK EDGE x 3/8 RECESS 5/8 TONGUE	FCM#1096	FCM#1116	
1047-AB 3/8 STICK EDGE x 1/2 RECESS 5/8 TONGUE	1081-AB 1/2 STICK EDGE x 5/8 RECESS 5/8 TONGUE ** MINIMUM DOOR 1 1/8			
1048-AB 1/4 STICK EDGE x 1/2 RECESS 5/8 TONGUE	1083-AB 3/16 STICK EDGE x 1/4 RECESS 3/8 TONGUE			
1052-AB 1/2 STICK EDGE x 9/16 RECESS 5/8 TONGUE				

GLASS DOOR & MUNTIN BAR

1021-AB 1/4 STICK EDGE x 9/16 RECESS	1024-AB 1/8 STICK EDGE x 1/2 RECESS	1029-AB 1/2 STICK EDGE x 3/8 RECESS	1033-A 3/8 STICK EDGE x 1/2 RECESS	1054-AB 1/16 VEE STICK EDGE x 1/4 RECESS 3/8 INSET WITH EASED EDGE	1057-AB 1/4 STICK EDGE x 7/16 RECESS	1062-AB 1/4 STICK EDGE x 9/16 RECESS	1064-AB 5/16 STICK EDGE x 3/8 RECESS	1064-AB 5/16 STICK EDGE x 7/16 RECESS	6057 "SHAKER" STYLE 1/4 RECESS	6057 "SHAKER" STYLE 3/8 RECESS	1070-AB 15/32 STICK EDGE x 13/16 RECESS ** MINIMUM DOOR 1 1/4	1073-AB 3/8 STICK EDGE x 1/2 RECESS	1079-AB 1/4 STICK EDGE x 11/16 RECESS ** MINIMUM DOOR 1 1/4	1083-CD 3/16 STICK EDGE x 1/4 RECESS	FCM#1114	FCM#1122
---	--	--	---------------------------------------	--	---	---	---	--	-----------------------------------	-----------------------------------	---	--	---	---	----------	----------

SOLID DOOR & GLASS DOOR MATCH SET

1033-AB 3/8 STICK EDGE x 1/2 RECESS 3/8 TONGUE	1037-AB 5/16 STICK EDGE x 3/8 RECESS 5/8 TONGUE	1037-AB 3/8 STICK EDGE x 7/16 RECESS 5/8 TONGUE	1040-AB 3/8 STICK EDGE x 1/2 RECESS 5/8 TONGUE	1053-AB 1/16 VEE STICK EDGE x FLUSH PANEL 5/8 TONGUE 3/8 INSET WITH EASED EDGE	1055-AB 1/4 STICK EDGE x 9/16 RECESS 5/8 TONGUE	1063-AB 1/4 STICK EDGE x 9/16 RECESS 5/8 TONGUE	1075-AB "SHAKER" STYLE x 1/4 RECESS 5/8 TONGUE	1075-AB "SHAKER" STYLE x 3/8 RECESS 5/8 TONGUE	1080-AB 3/8 STICK EDGE x 3/8 RECESS 5/8 TONGUE	1083-AB 3/16 STICK EDGE x 1/4 RECESS 3/8 TONGUE	1033-A 3/8 STICK EDGE x 1/2 RECESS	1064-AB 5/16 STICK EDGE x 3/8 RECESS	1064-AB 5/16 STICK EDGE x 7/16 RECESS	1073-AB 3/8 STICK EDGE x 1/2 RECESS	1054-AB 1/16 VEE STICK EDGE x 1/4 RECESS 3/8 INSET WITH EASED EDGE	1057-AB 1/4 STICK EDGE x 7/16 RECESS	1062-AB 1/4 STICK EDGE x 9/16 RECESS	6057 "SHAKER" STYLE 1/4 RECESS	6057 "SHAKER" STYLE 3/8 RECESS	1080-CD 3/8 STICK EDGE x 3/8 RECESS	1083-CD 3/16 STICK EDGE x 1/4 RECESS
--	---	---	--	---	---	---	--	--	--	---	---------------------------------------	---	--	--	--	---	---	-----------------------------------	-----------------------------------	--	---

1 1/4" DOOR

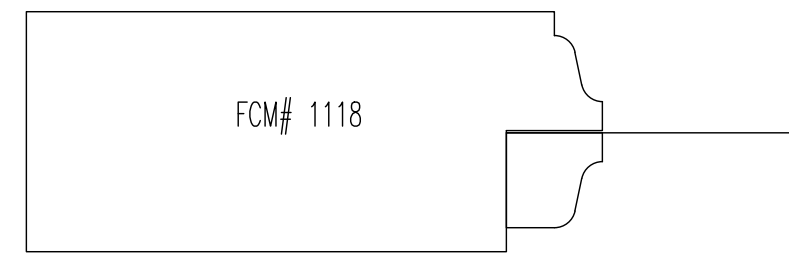
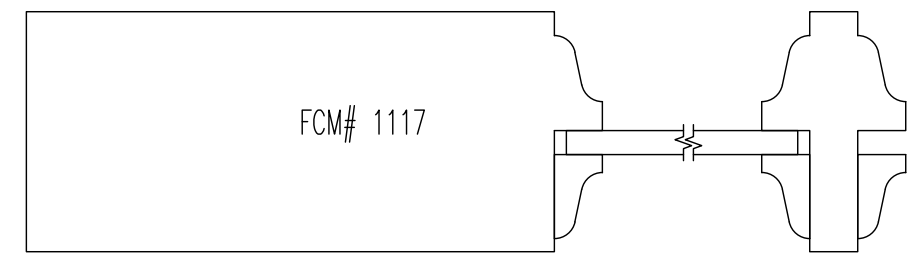
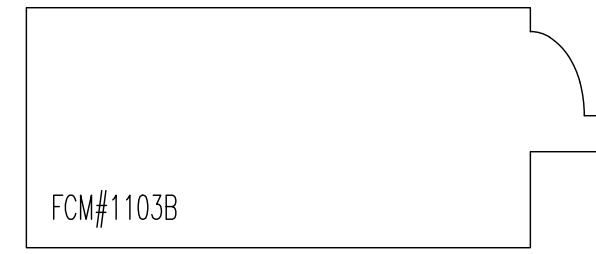
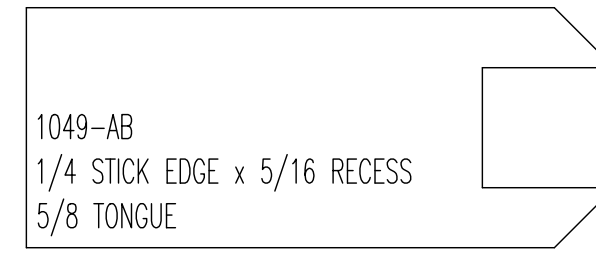

1 3/8" DOOR

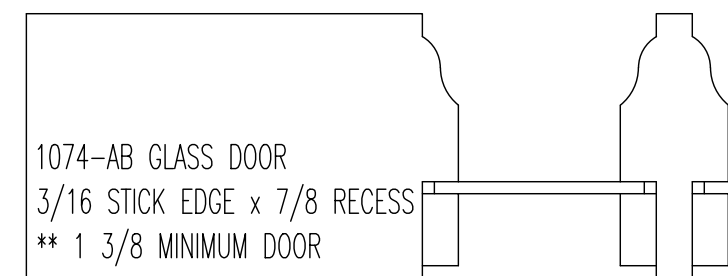
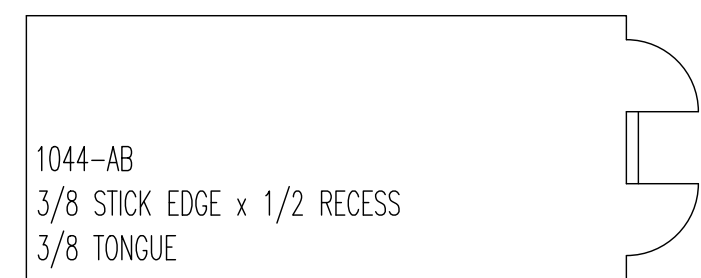

1 1/2" DOOR

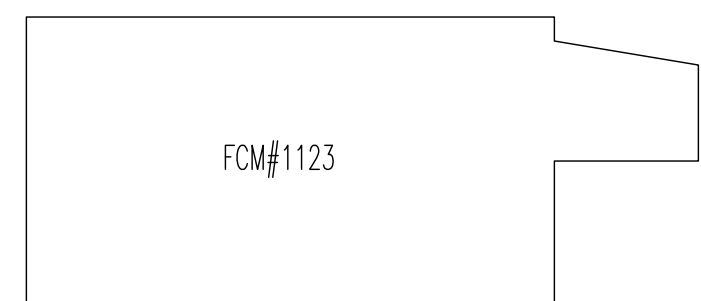

1 1/2" GLASS DOOR w/MUNTIN BAR

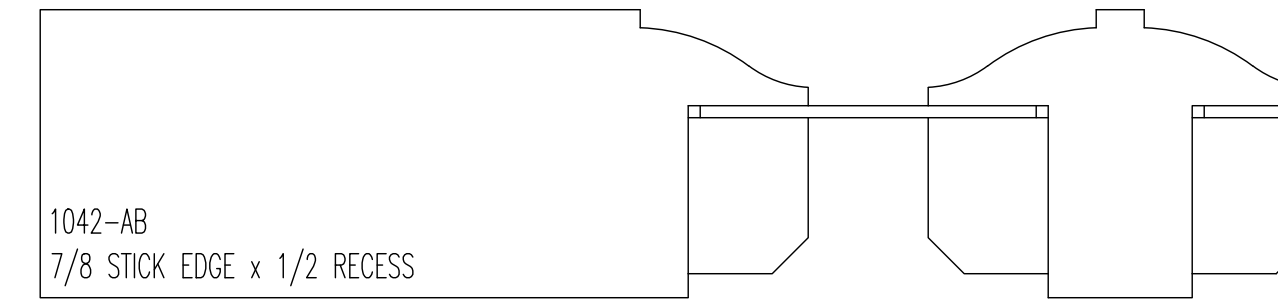
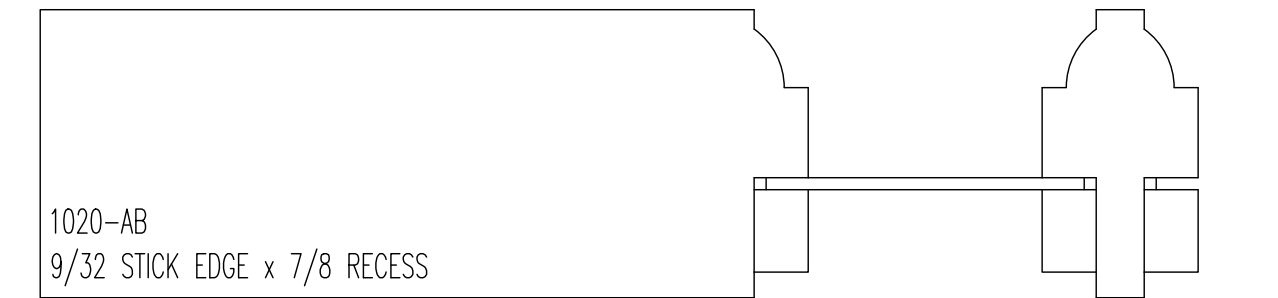
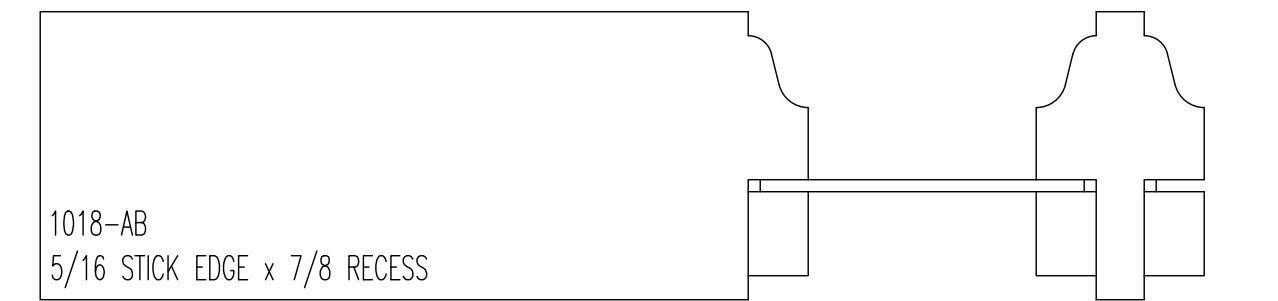
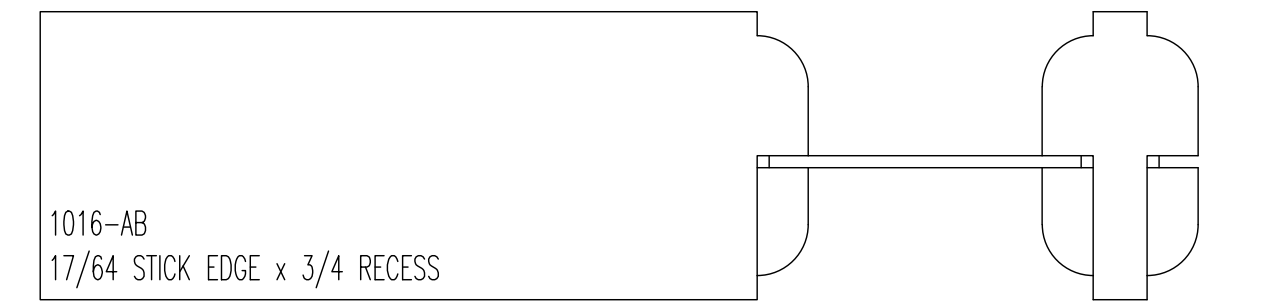
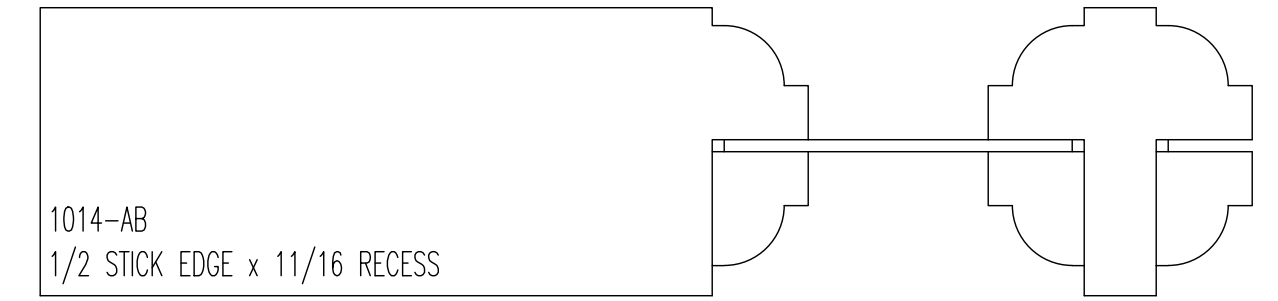
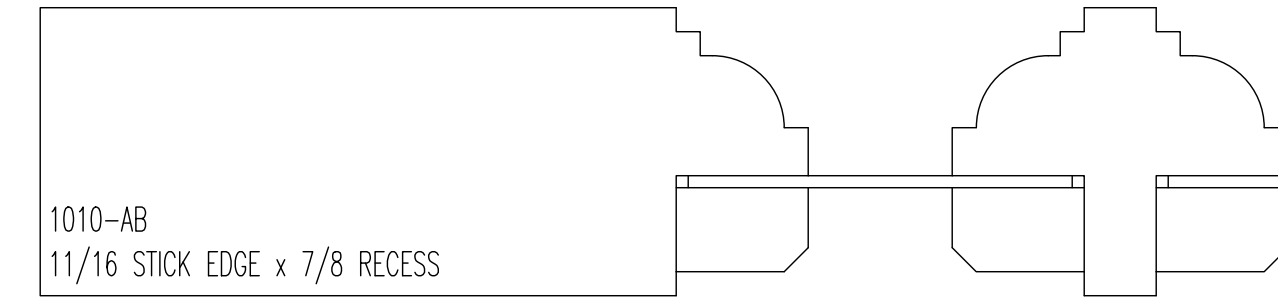

1 3/4" GLASS DOOR w/MUNTIN BAR

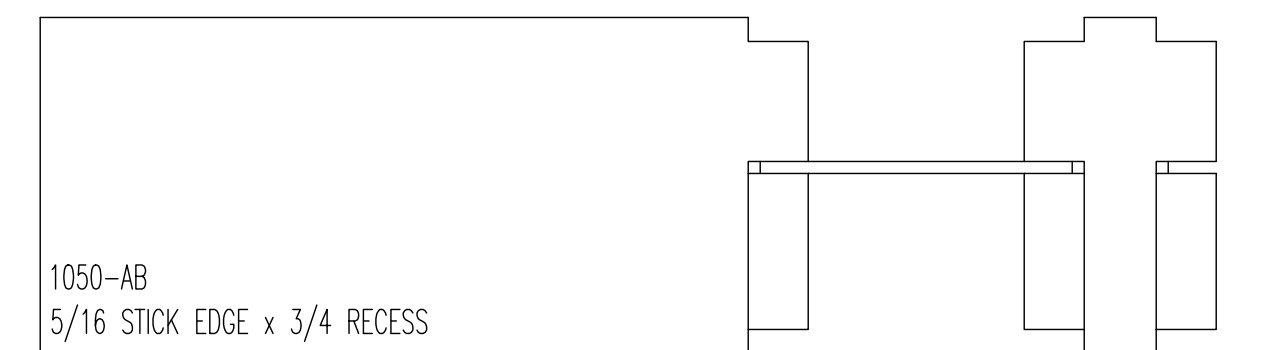
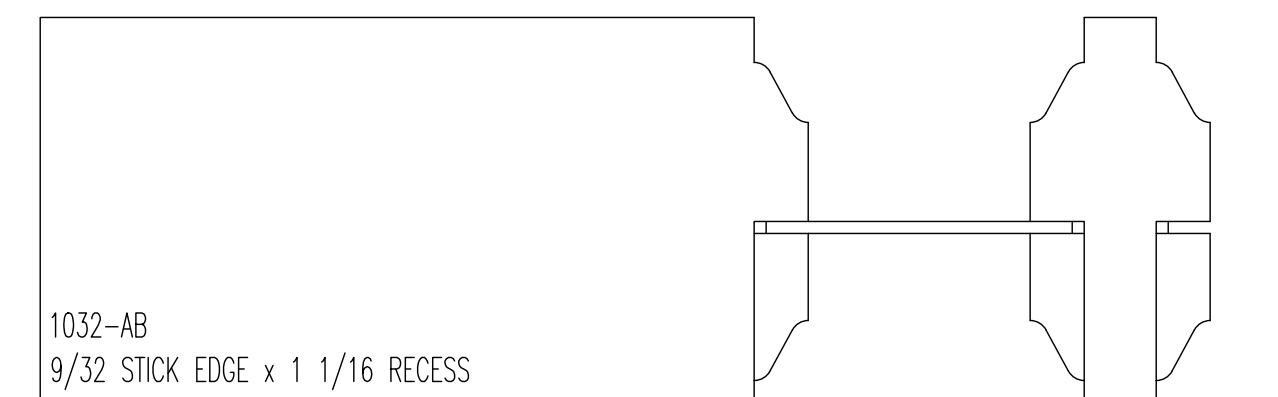

2 1/4" GLASS DOOR w/MUNTIN BAR

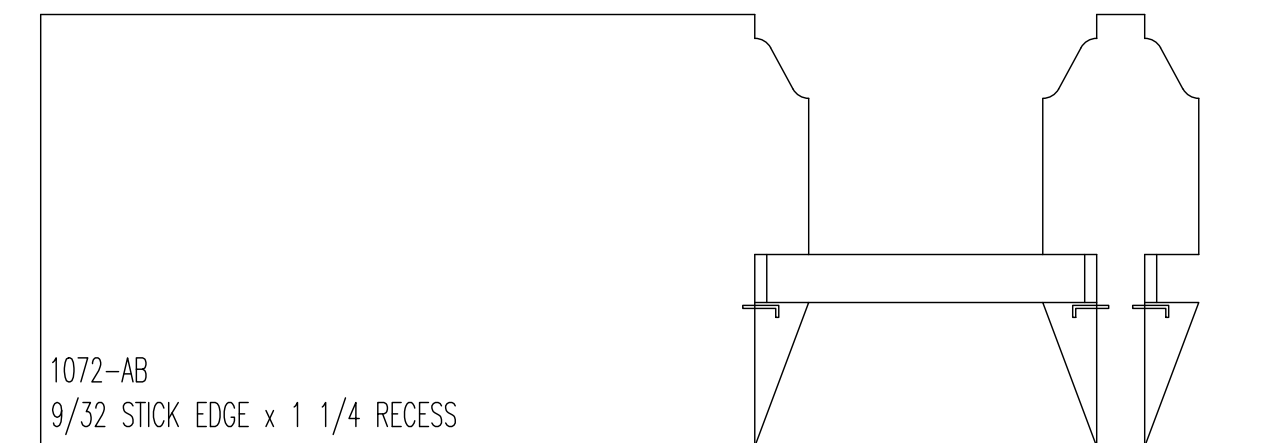

1 3/4" DOOR

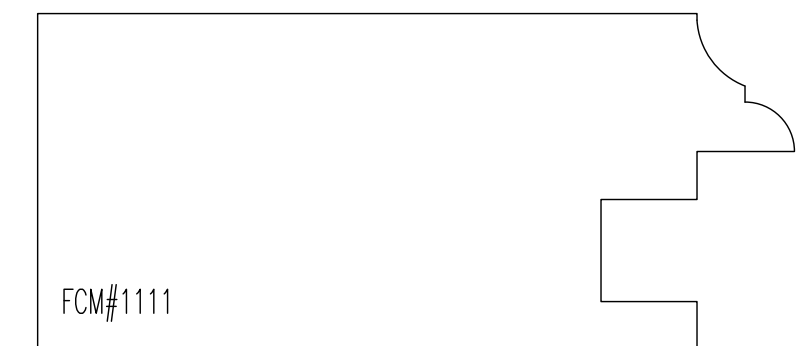
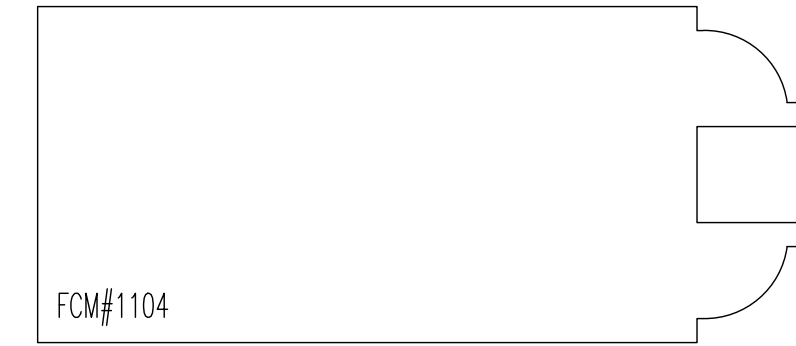

RAISED PANEL PROFILES

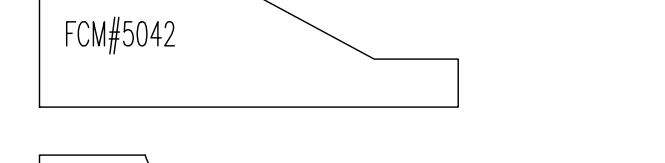
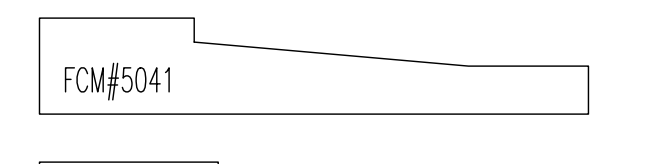
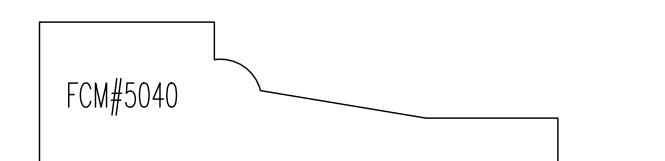
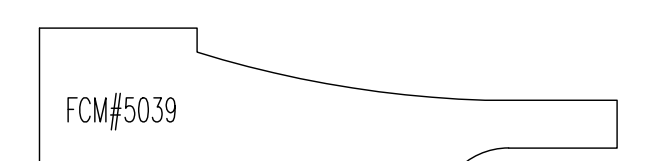
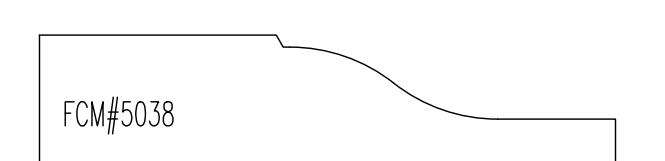
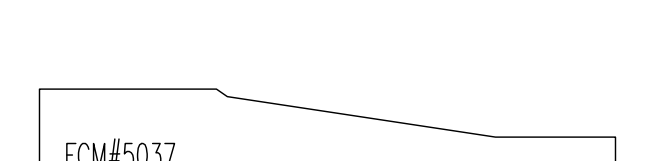
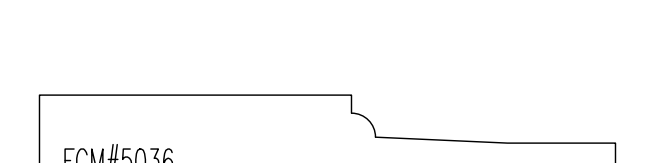
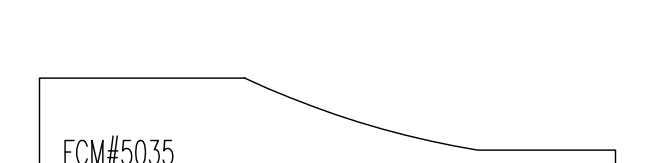
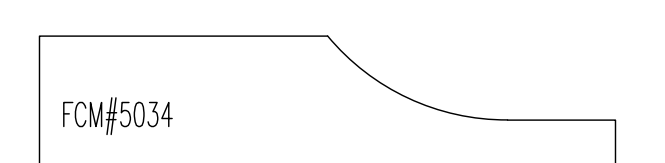
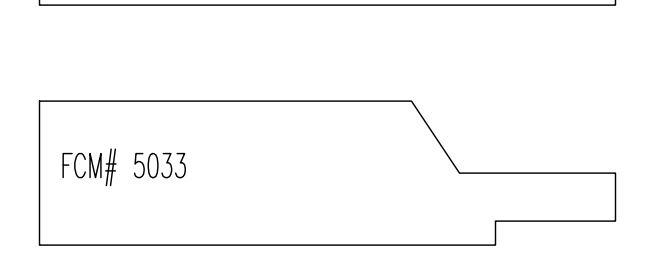
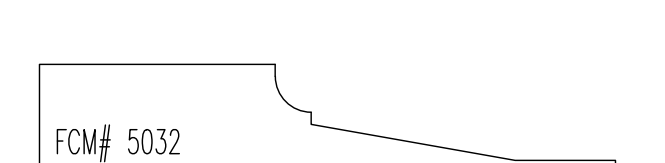
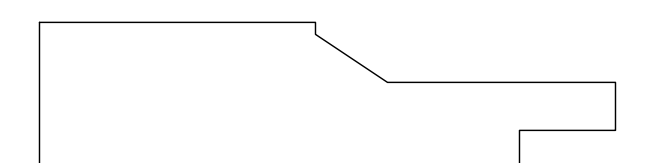
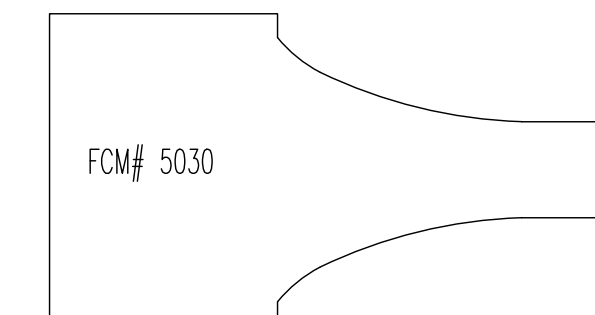
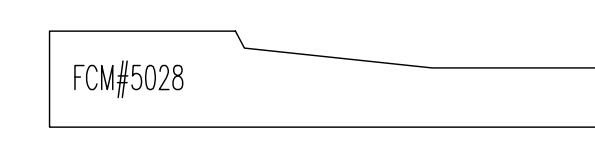
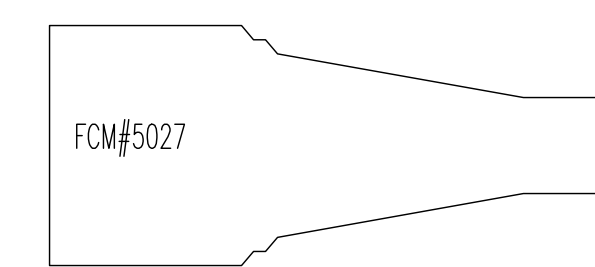
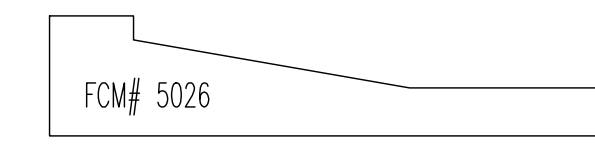
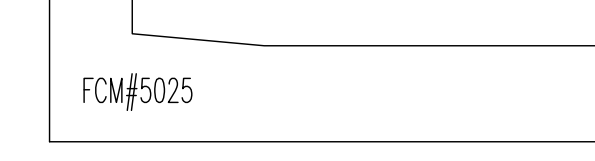
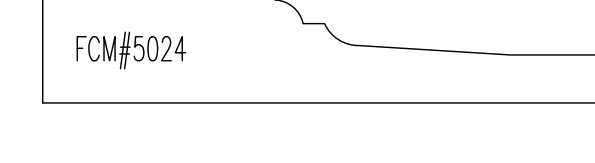
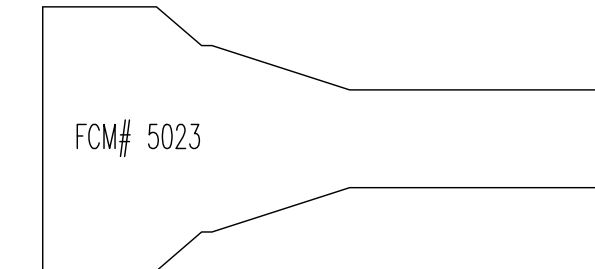
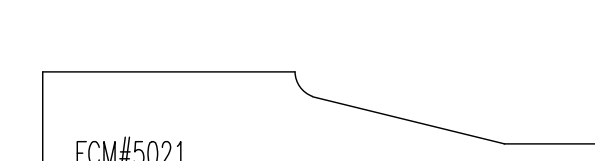
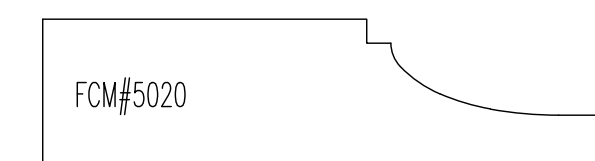
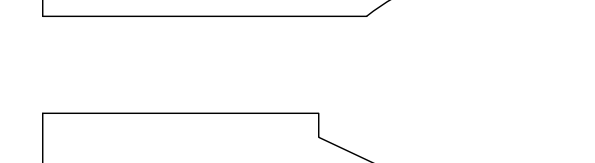
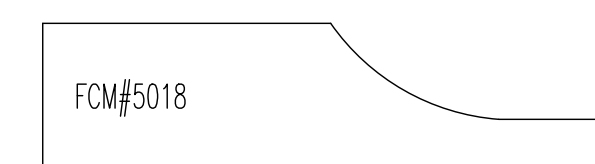
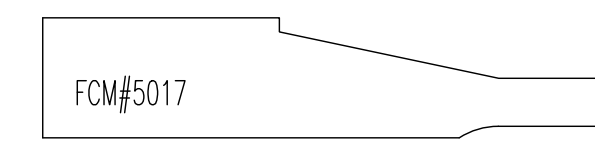
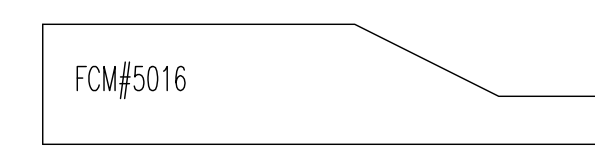
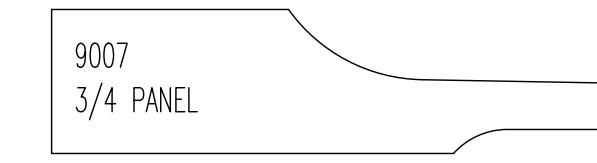
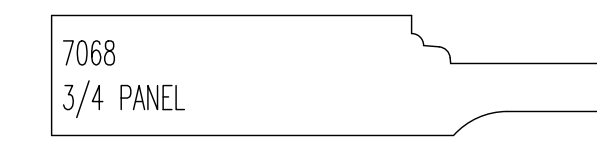
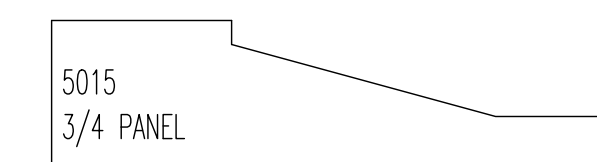
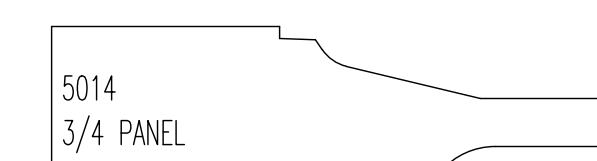
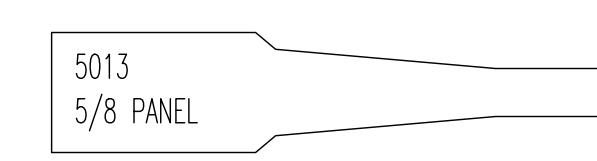
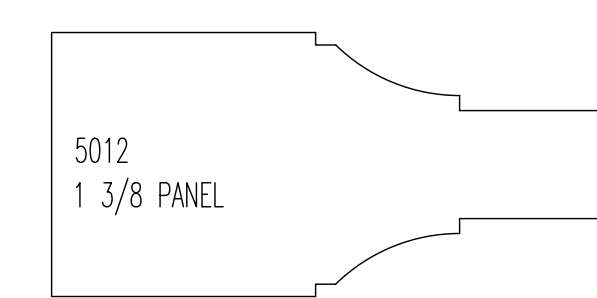
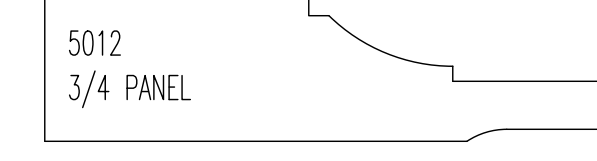
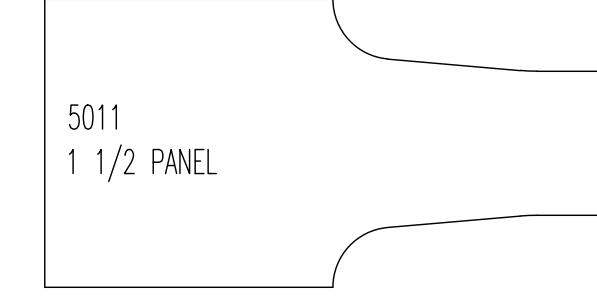
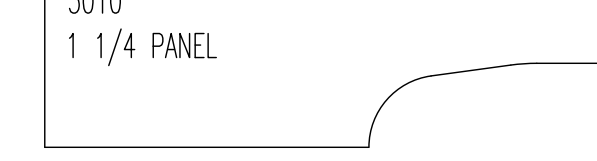
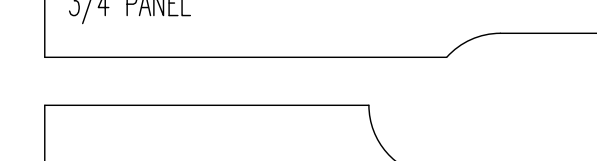
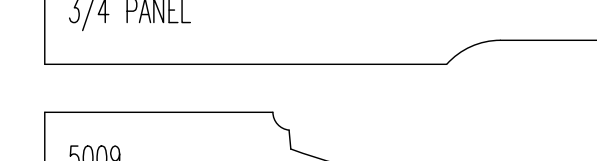
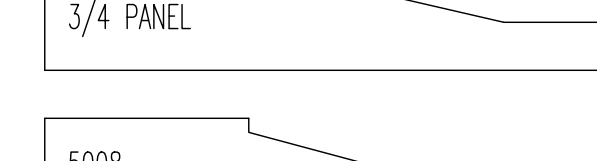
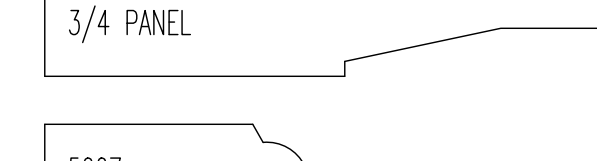
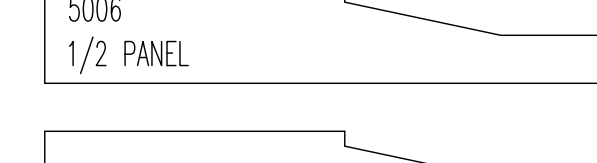
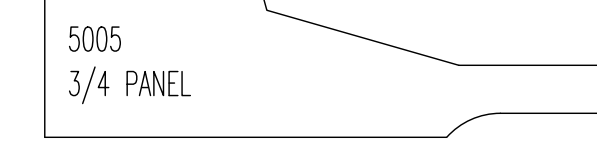
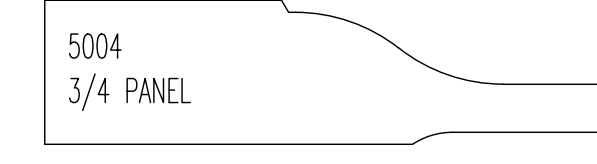
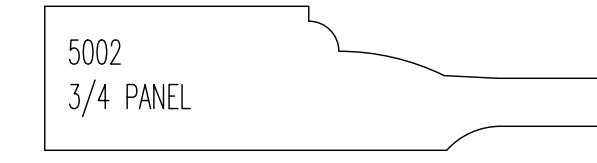
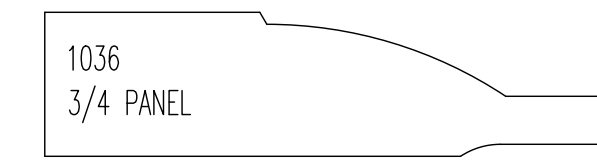

PANEL MOULD

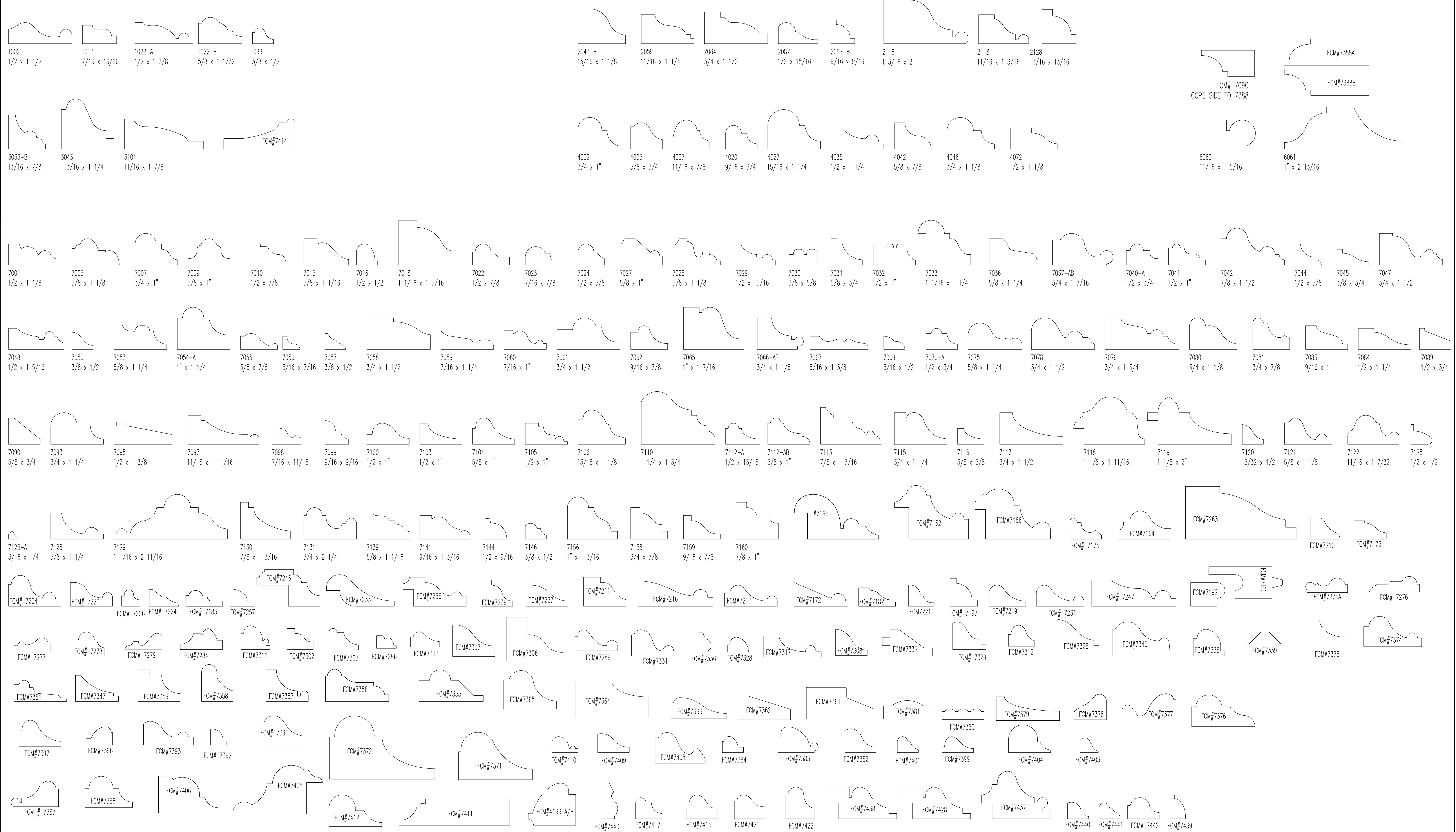

CHAIR RAIL

2005
1 7/80 x 2 1/2H

2007
1 5/80 x 1 3/4H

2014
1 7/80 x 2 3/4H

2015
2 1/40 x 2 3/8H

2016
1 3/40 x 1 7/8H

2023
1 1/20 x 1 5/8H

2024
1 7/80 x 3H

2026
1 3/40 x 3 1/4H

2029
1 7/80 x 2 3/8H

2032
1 1/20 x 1 3/4H

2033
1 3/40 x 3 1/2H

2034
1 5/80 x 2H

2038
2 1/40 x 2H

2039
1 7/80 x 3H

2040
1 5/80 x 2H

2047
1 13/160 x 3 1/4H

2048
1 3/40 x 2H

FCM2050
1 5/80 x 2 1/8H

2052
2D x 2 1/4H

2053
1 3/4D x 2 1/4H

2056
3/4 x 5"

6032-AB
7/8 x 5 1/8

2066
2D x 6H

2070
1 1/160 x 2H

2077
2 1/80 x 3 1/2H

2078
2 1/40 x 3 1/8H

2080
1 5/80 x 3 9/16H

2100
1 3/160 x 1 9/16H

2106
1 5/80 x 2 3/8H
WITH 3099 CROWN

2117-AB
1 9/16 x 3 1/2H

2123
1 1/40 x 3 1/4H

FCM#2182

4012
1 3/40 x 1H
WITH 2085 CASING

4019
1 1/20 x 2H

4049
1 3/40 x 1 3/8H

6004
1 3/40 x 2 15/16H

6032-AB
7/8 x 5 1/8

7019
1 3/40 x 1H

7118
1 5/80 x 1 11/16H

FCM#2182

FCM#2192

FCM#2195

FCM# 2152

FCM#2164

FCM#2305

FCM# 2145

WALL PANEL

FCM#9047

6044-AB
3/4 x 2 3/4 O.C. EASED EDGE

6045-AB
3/4 x 4 O.C. WITH 3/32 REVEAL

9006
3/4 x 2 O.C.

9008 & 9009
3/4 x 3 O.C. WITH 3/16 x 3/8 VEE

9008 & 9009
3/4 x 3 O.C. WITH 1/16 x 1/8 VEE

9010
3/4 x 2 5/16 O.C.

9012
3/4 x 5 1/8 O.C.

9013-AB x BEAD CENTER AS REQUIRED
(SHOWN 3/4 x 2 3/4 O.C.)
CNC STAR WHEEL TOOLING AVAILABLE

9014
3/4 x 4" O.C.

9017
3/4 x 2" O.C.

9018
3/4 x 2" O.C.

9020
3/4 x 3 3/4 O.C.

9021
3/4 x 3" O.C.

9022
3/4 x 4" O.C.
CNC STAR WHEEL TOOLING AVAILABLE

9027 x BEAD CENTER AS REQUIRED
MAXIMUM 6" O.C. [SHOWN WITH 4" O.C.]
CNC STAR WHEEL TOOLING AVAILABLE

9027-B x BEAD CENTER AS REQUIRED
MAXIMUM 6" O.C. [SHOWN WITH 4" O.C.]

FCM#6123

FCM#6122

FCM#6124

FCM#9046

FCM#9051

FCM#9048

FCM#9049

FCM#9035

FCM# 9031

FCM#9036

FCM#9038

FCM#9037

FCM#9044

FCM 9039

FCM#9043

FCM#9045

ASTRAGAL

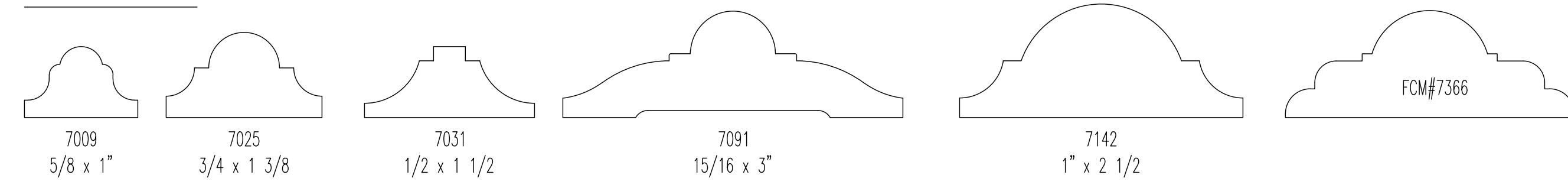

CORNER BEAD

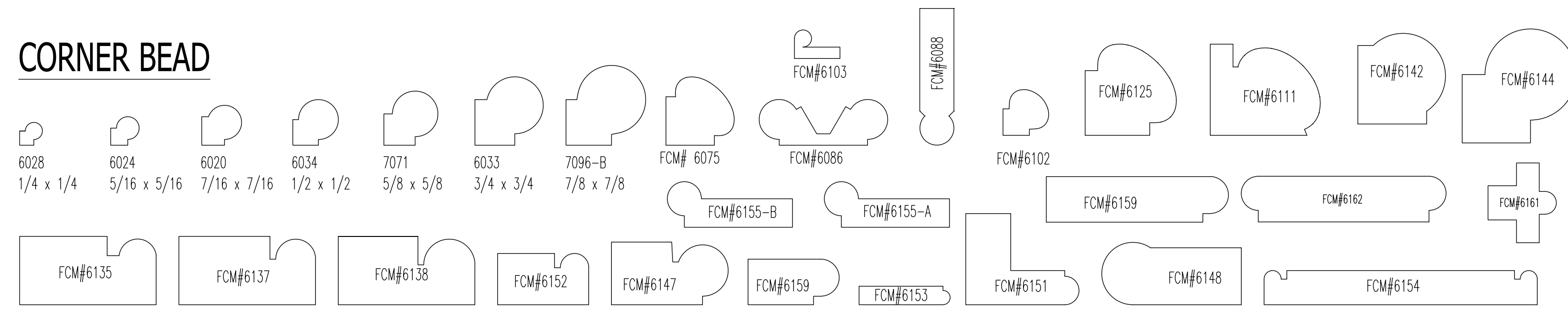

COVE

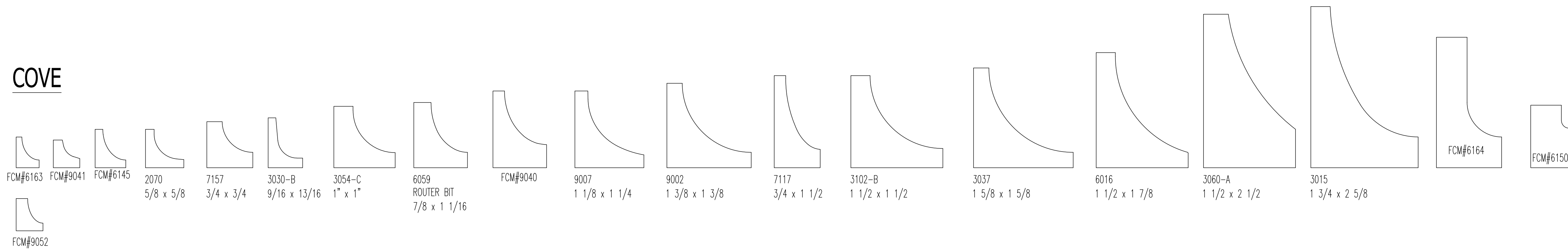

ONLAY

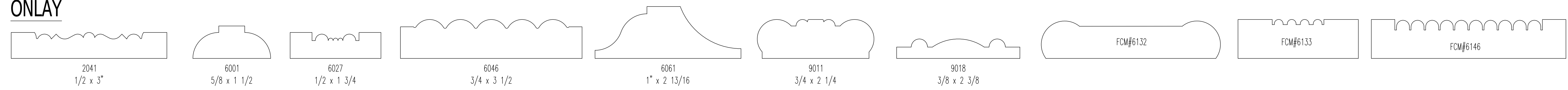

PICTURE RAIL

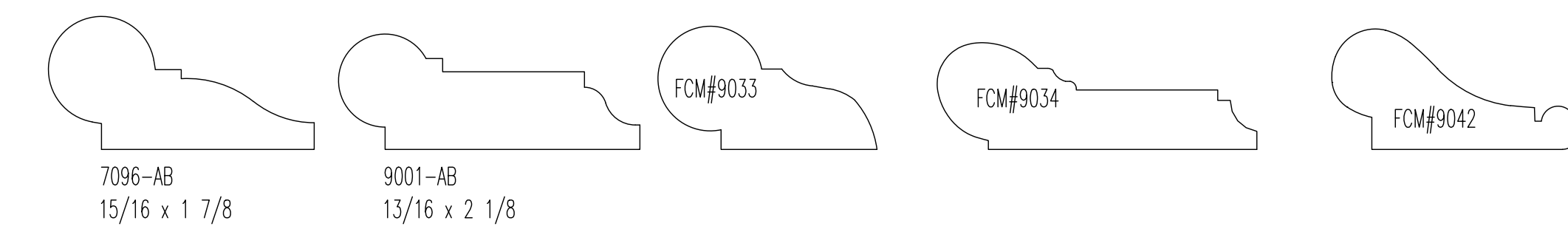

ROSETTE

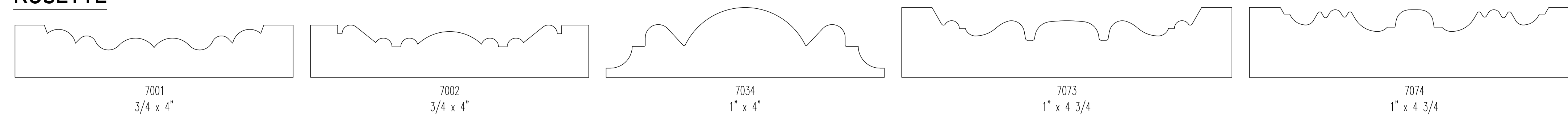

MISC SHAPES

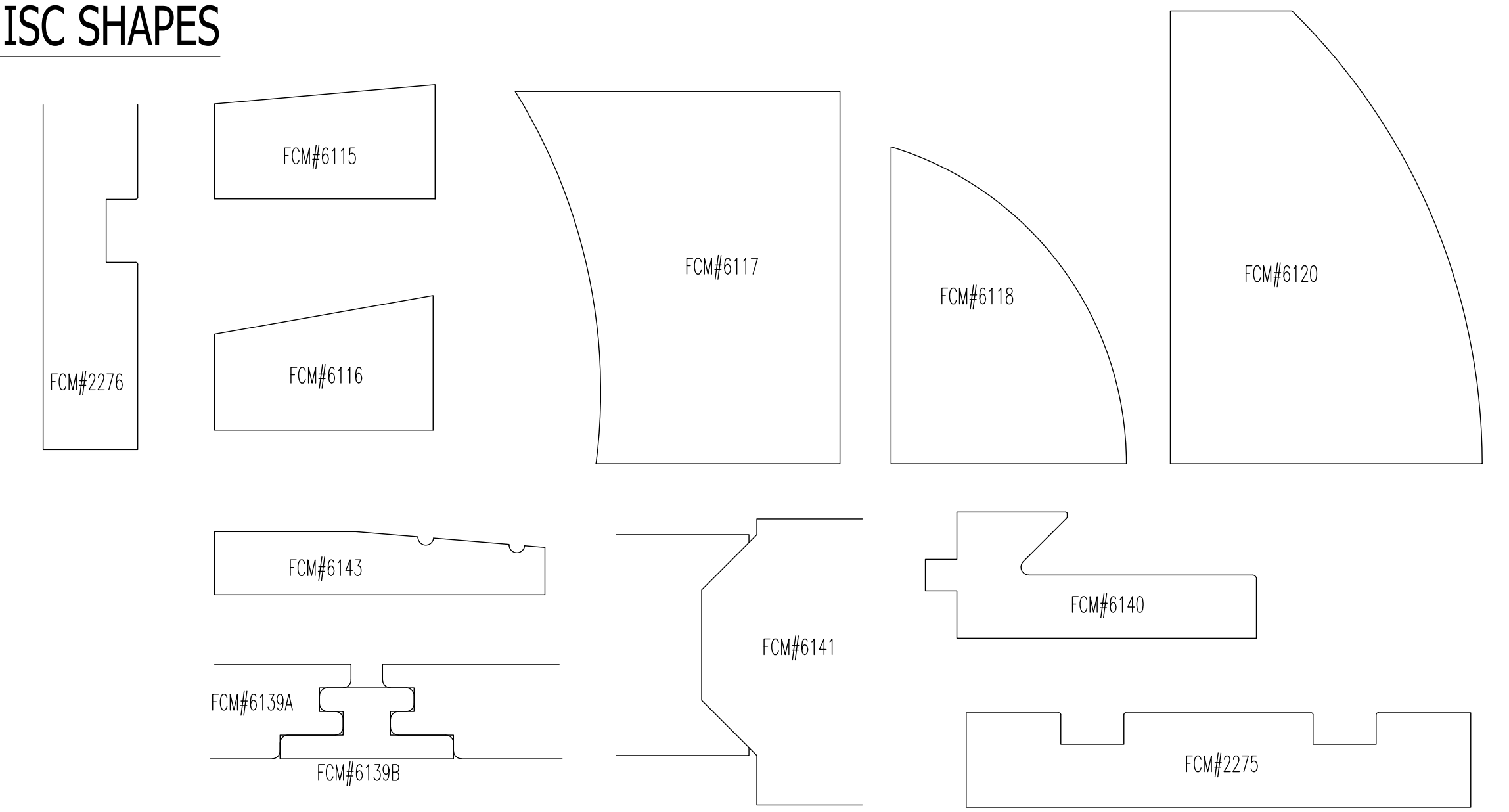

BAR RAIL

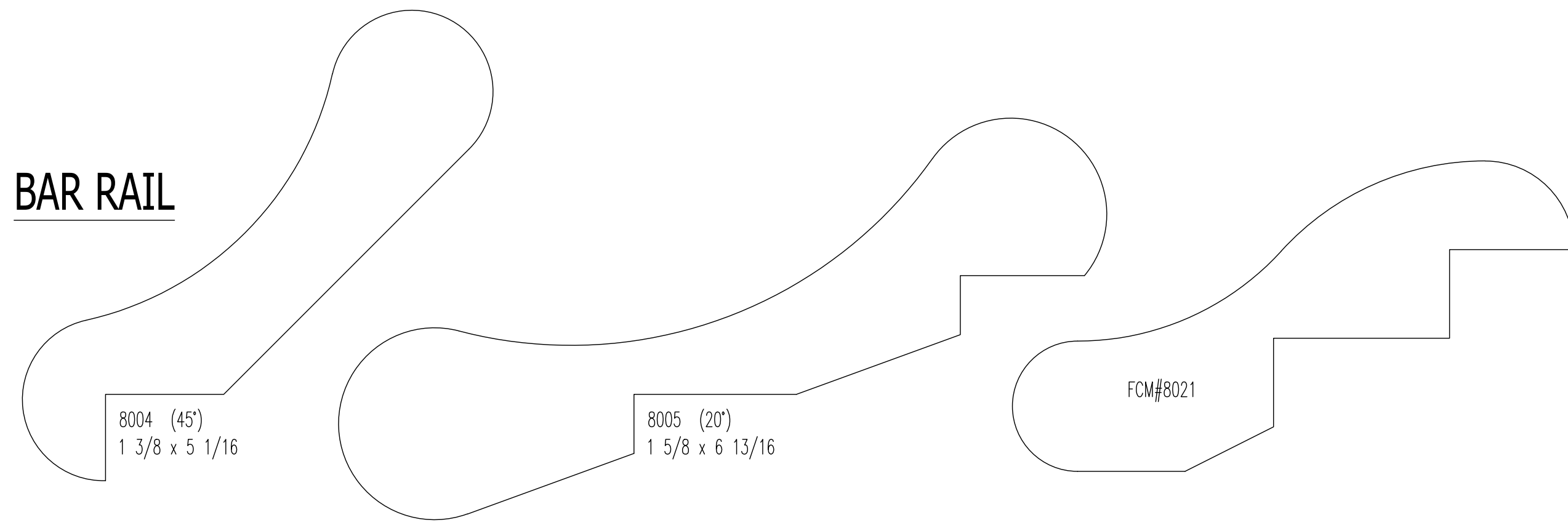

HAND RAIL

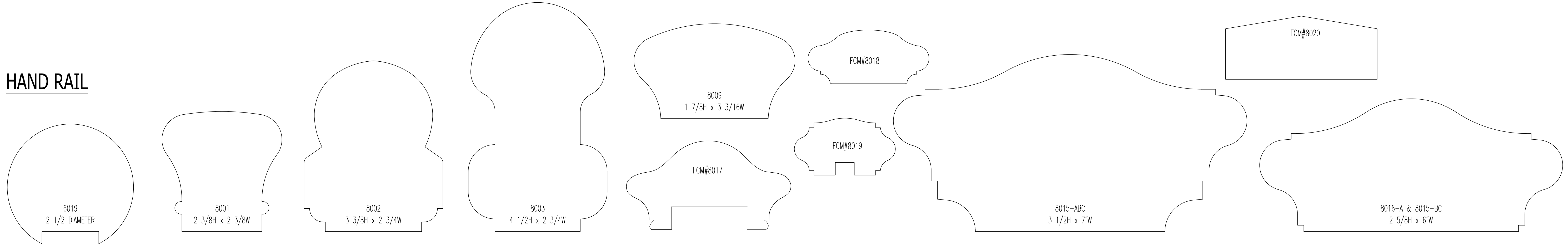

BOLECTION

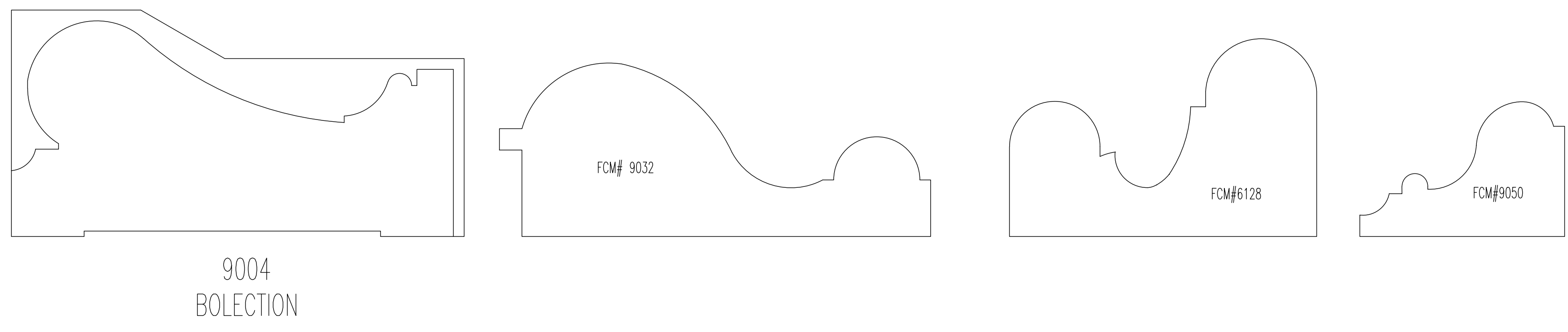

DENTIL

